

2024 PRODUCTS CATALOG

ABRASIVES - BRUSHES - COBALT DRILLBITS
MARKERS - TOOLING - FLAP DISCS



ADVANCED SOLUTIONS FOR SURFACES

SUPPLIER LOGO:

Metaflux

PRODUCT NAME

Metacut Premium

OSA:

EN 12413

PRODUCT NUMBER:

82-0044

MAX RPM:

12 250 RPM

PRECAUTION:

Security symbols

ORIGIN:

Made in Germany

EÜ DISTRIBUTOR:

Available here in Europe

great for:

STEEL SST

DISC THICKNESS:

1 MM. / 3/64"

ARBOR SIZE:

22,23 MM. / 7/8"

DISC SIZE:

125 MM. / 5"

BF

Reinforced Resin

A46U

GRIT

WARNING

For cutting only

SUPPLIER ADDRESS

CH 4313 MOHLIN, GERMANY











Ameta's cutting and grinding discs offer you the best solution for the most demanding users, combining a competitive price & quality ratio in order to keep industrial operations economical. We've been in this domain for more than 20 years.

- A selection of bonded, coated and non-woven abrasives for professional, industrial and standard works.
- A variety of products representing the best of German and Italian abrasive technology
- Cut-off and grinding discs to meet any application requirements
- Heavy duty trimmable flap discs with top quality ceramic and zirconium cloth for fast and high removal rate
- Grinding abrasives for accurate end results



> **INDUSTRIAL CUTTING**

HIGH PERFORMANCE LINE CUTTING 3" TO 9"

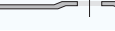
Dimension (inches)	Material	Art.-No	Type	Max R.P.M.	
3 x 3/64 [.045] x 3/8	▲ ▲ ▲	87-9499		20 100	25
3 x 5/64 [.078] x 3/8	▲ ▲ ▲	62-3564		20 380	100
4 1/2 x 3/64 [.045] x 7/8	▲ ▲ ▲	82-0033		13 300	50
5 x 0.6mm [.02] x 7/8	▲	82-0046		12 250	50
5 x 3/64 [.045] x 7/8	▲ ▲ ▲	82-0044		12 250	50
6 x 1/16 [.062] x 7/8	▲ ▲ ▲	62-1160		10 200	25
7 x 1/16 [.062] x 7/8	▲ ▲ ▲	82-0050		8 500	25
9 x 5/64 [.078] x 7/8	▲ ▲ ▲	82-0060		6 650	25

▲ Steel ▲ SST ▲ Titanium ▲ Cast & PVC ▲ Aluminum

> **GREAT FOR SST**











The long-life **GERMAN CUT** and **Metacut Premium** cutting discs are designed to offer excellent cutting speed as well as an extended duration under all conditions of use.

Its special formulation guarantees no contamination on SST or titanium. Iron, sulfur and chloride <0.1%

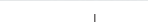

> COMMERCIAL CUTTING

STANDARD PERFORMANCE 3" TO 7"

Dimension (inches)	Material	Art.-No	Type	Max R.P.M.	
3 x 3/64 [.045] x 3/8	▲ ▲ ▲	62-0312		20 380	100
3 x 5/64 [.078] x 3/8	▲ ▲ ▲	62-0315		20 380	100
4 1/2 x 3/64 [.045] x 7/8	▲ ▲ ▲	62-0011		13 300	50
4 1/2 x 3/64 [.045] x 7/8	▲ ▲ ▲	62-2711		13 300	25
5 x 3/64 [.045] x 7/8	▲ ▲ ▲	62-0021		12 200	50
5 x 3/64 [.045] x 7/8	▲ ▲ ▲	62-2721		12 200	25
6 x 1/16 [.062] x 7/8	▲ ▲ ▲	62-0061		10 200	25
6 x 1/16 [.062] x 7/8	▲ ▲ ▲	62-2761		10 200	25
7 x 1/16 [.062] x 7/8	▲ ▲ ▲	62-0071		8 500	25
7 x 1/16 [.062] x 7/8	▲ ▲ ▲	62-2771		8 500	25

▲ Steel ▲ SST ▲ Titanium ▲ Cast & PVC ▲ Aluminum

> **GREAT FOR STEEL**

EZ-CUT cut-off discs provide an extremely balanced quality /price ratio for competitive industrial cutting.

Its formulation guarantees no contamination on stainless steel or titanium.





CUTTING & GRINDING 2"

INDUSTRIAL QUALITY

Dimension (inches)	Material	Art.-No	Type	Use	Max R.P.M.	
2 x 1/16 x 3/8	▲ ▲ ▲	62-2116	— —	CUTTING	30 560	100
2 x 1/8 x 3/8	▲ ▲ ▲	62-2018	— —	CUTTING	30 560	100
2 x 1/4 x 3/8	▲ ▲ ▲	62-2014	— —	GRINDING	23 000	50
2 x 1/2 x 3/8	▲ ▲ ▲	62-2012	— —	GRINDING	23 000	50

▲ Steel ▲ SST ▲ Titanium ▲ Cast & PVC ▲ Aluminum



CUTTING & GRINDING 3"

INDUSTRIAL QUALITY

Dimension (inches)	Material	Art.-No	Type	Use	Max R.P.M.	
3 x 3/64 [.045] x 3/8	▲ ▲ ▲	87-9499	— —	CUTTING	20 100	25
3 x 5/64 x 3/8	▲ ▲ ▲	62-3564	— —	CUTTING	20 380	50
3 x 3/64 x 3/8	▲ ▲ ▲	62-0312	— —	CUTTING	20 380	50
3 x 3/64 x 3/8	▲	52-0312	— —	CUTTING	20 380	50
3 x 3/64 x 1/4	▲ ▲ ▲	62-1312	— —	CUTTING	20 380	50
3 x 1/16 x 3/8	▲ ▲ ▲	62-0315	— —	CUTTING	20 380	50
3 x 1/16 x 1/4	▲ ▲ ▲	62-1315	— —	CUTTING	20 380	50
3 x 5/64 x 3/8	▲ ▲ ▲	62-3564	— —	CUTTING	20 380	100
3 x 1/8 x 1/4	▲ ▲ ▲	62-3018	— —	combined	20 380	50
3 x 1/8 x 3/8	▲ ▲ ▲	62-0318	— —	combined	20 380	50

▲ Steel ▲ SST ▲ Titanium ▲ Cast & PVC ▲ Aluminum

ADAPTOR FOR 2" & 3" ABRASIVES

72-000A: 3/8" SHAFT BLACK

72-000B: 1/4" SHAFT GOLD

Allows any die grinder or drill to be turned into a cut-off tool using either 1/4" or 3/8" I.D. Cut-Off wheels.



CUTTING & GRINDING 4"

INDUSTRIAL QUALITY

Dimension (inches)	Material	Art.-No	Type	Use	Max R.P.M.	
4 x 3/64 x 3/8	▲ ▲ ▲	62-0412	— —	CUTTING	15 300	50
4 x 3/64 x 5/8	▲ ▲ ▲	62-4132	— —	CUTTING	15 300	50
4 x 1/16 x 3/8	▲ ▲ ▲	62-0415	— —	CUTTING	15 300	50
4 x 1/16 x 5/8	▲ ▲ ▲	62-4116	— —	CUTTING	15 300	50
4 x 1/4 x 3/8	▲ ▲ ▲	62-4014	— —	GRINDING	15 300	25
4 x 1/4 x 5/8	▲	82-1500	— —	GRINDING	15 300	25

▲ Steel ▲ SST ▲ Titanium ▲ Cast & PVC ▲ Aluminum



CUTTING 4 1/2"

INDUSTRIAL QUALITY

Dimension (inches)	Material	Art.-No	Type	Use	Max R.P.M.	
4 1/2 x 1.0mm x 7/8	▲▲▲	62-0001		CUTTING	13 300	50
4 1/2 x 1/32 x 7/8	▲▲▲	62-0006		CUTTING	13 300	50
4 1/2 x 1/32 x 7/8	▲▲▲▲	62-0005		CUTTING	13 300	50
4 1/2 x 3/64 x 7/8	▲▲▲	62-0011		CUTTING	13 300	50
4 1/2 x 3/64 x 7/8	▲▲▲	62-2711		CUTTING	13 300	50
4 1/2 x 3/64 x 7/8	▲▲▲	82-0033		CUTTING	13 300	50
4 1/2 x 3/64 x 7/8	▲▲▲▲	62-0010		CUTTING	13 300	50
4 1/2 x 3/64 x 7/8	▲	52-0001		CUTTING	13 300	50
4 1/2 x 3/64 x 7/8	▲	52-2701		CUTTING	13 300	50
4 1/2 x 1/16 x 7/8	▲▲▲	62-4616		CUTTING	13 300	50
4 1/2 x 1/16 x 7/8	▲▲▲	62-4516		CUTTING	13 300	50
4 1/2 x 5/64 x 7/8	▲	82-0245		CUTTING	13 300	50
4 1/2 x 5/64 x 7/8	▲	62-0245		CUTTING	13 300	50
4 1/2 x 3/32 x 7/8	▲	62-3245		CUTTING	13 300	50
4 1/2 x 3/32 x 7/8	▲	62-4532		CUTTING	13 300	50
4 1/2 x 1/8 x 7/8	▲	82-1100		CUTTING	13 300	50
4 1/2 x 1/8 x 7/8	▲	62-1100		CUTTING	13 300	50
4 1/2 x 1/8 x 7/8	▲	52-1100		CUTTING	13 300	50

▲ Steel ▲ SST ▲ Titanium ▲ Cast & PVC ▲ Aluminum



ECONOMIC QUALITY / PRICE



GREAT FOR SST

ECONOMIC QUALITY / PRICE

ECONOMIC QUALITY / PRICE



GRINDING 4 1/2"

INDUSTRIAL QUALITY

Dimension (inches)	Material	Art.-No	Type	Use	Max R.P.M.	
4 1/2 x 1/4 x 7/8	▲	52-1600		GRINDING	13 300	25
4 1/2 x 1/4 x 7/8	▲	62-1600		GRINDING	13 300	25
4 1/2 x 1/4 x 7/8	▲	82-1600		GRINDING	13 300	25
4 1/2 x 1/4 x 7/8	▲	82-1601		GRINDING	13 300	25

▲ Steel ▲ SST ▲ Titanium ▲ Cast & PVC ▲ Aluminum



X-TRA LONG LIFE

CUTTING 5"

INDUSTRIAL QUALITY

Dimension (inches)	Material	Art.-No	Type	Use	Max R.P.M.	
5 x 0.6mm x 7/8	▲	82-0046		CUTTING	12 250	50
5 x 1.0mm x 7/8	▲▲▲	62-0002		CUTTING	12 200	50
5 x 1/32 x 7/8	▲▲▲	62-0026		CUTTING	12 200	50
5 x 1/32 x 7/8	▲▲▲	62-0025		CUTTING	12 200	50
5 x 3/64 x 7/8	▲▲▲	62-0021		CUTTING	12 200	50
5 x 3/64 x 7/8	▲▲▲	62-2721		CUTTING	12 200	50
5 x 3/64 x 7/8	▲▲▲	82-0044		CUTTING	12 250	50
5 x 3/64 x 7/8	▲▲▲	62-0020		CUTTING	12 200	50
5 x 3/64 x 7/8	▲▲▲	62-2720		CUTTING	12 200	50
5 x 3/64x 7/8	▲	52-0002		CUTTING	12 200	50
5 x 3/64 x 7/8	▲	52-2702		CUTTING	12 200	50
5 x 1/16 x 7/8	▲▲▲	62-5516		CUTTING	12 200	50
5 x 1/16 x 7/8	▲▲▲	62-0516		CUTTING	12 200	50
5 x 5/64 x 7/8	▲	82-0205		CUTTING	12 200	50
5 x 5/64 x 7/8	▲	62-0205		CUTTING	12 200	50
5 x 3/32 x 7/8	▲	62-0532		CUTTING	12 200	50
5 x 1/8 x 7/8	▲	82-1200		CUTTING	12 200	50
5 x 1/8 x 7/8	▲	62-1200		CUTTING	12 200	50
5 x 1/8 x 7/8	▲	52-1200		CUTTING	12 200	50

▲ Steel ▲ SST ▲ Titanium ▲ Cast & PVC ▲ Aluminum

GRINDING 5"

INDUSTRIAL QUALITY

Dimension (inches)	Material	Art.-No	Type	Use	Max R.P.M.	
5 x 1/4 x 7/8	▲	52-1700		GRINDING	12 200	25
5 x 1/4 x 7/8	▲	62-1700		GRINDING	12 200	25
5 x 1/4 x 7/8	▲	82-1700		GRINDING	12 200	25
5 x 1/4 x 7/8	▲	82-1701		GRINDING	12 200	25

▲ Steel ▲ SST ▲ Titanium ▲ Cast & PVC ▲ Aluminum



ECONOMIC QUALITY / PRICE



GREAT FOR SST
ECONOMIC QUALITY / PRICE
ECONOMIC QUALITY / PRICE



X-TRA LONG LIFE

> CUTTING 6"

INDUSTRIAL QUALITY						
Dimension (inches)	Material	Art.-No	Type	Use	Max R.P.M.	Box
6 x 3/64 x 7/8	▲ ▲ ▲	62-0060	— —	CUTTING	10 200	25
6 x 3/64 x 7/8	▲ ▲ ▲	62-0061	— —	CUTTING	10 200	25
6 x 3/64 x 7/8	▲ ▲ ▲	62-2761	— —	CUTTING	10 200	25
6 x 3/64 x 7/8	▲	52-0003	— —	CUTTING	10 200	50
6 x 3/64 x 7/8	▲	52-2703	— —	CUTTING	10 200	50
6 x 1/16 x 7/8	▲ ▲ ▲	62-1160	— —	CUTTING	10 200	25
6 x 1/16 x 7/8	▲ ▲ ▲	62-6616	— —	CUTTING	10 200	25
6 x 3/32 x 7/8	▲	62-3206	— —	CUTTING	10 200	50

▲ Steel ▲ SST ▲ Titanium ▲ Cast & PVC ▲ Aluminum



> ECONOMIC QUALITY / PRICE



> GREAT FOR SST



> GRINDING 6"

INDUSTRIAL QUALITY						
Dimension (inches)	Material	Art.-No	Type	Use	Max R.P.M.	Box
6 x 1/4 x 7/8	▲	82-1801	— —	GRINDING	10 200	25
6 x 1/4 x 7/8	▲	62-1800	— —	GRINDING	10 200	25

▲ Steel ▲ SST ▲ Titanium ▲ Cast & PVC ▲ Aluminum



> X-TRA LONG LIFE



> CUTTING 7"

INDUSTRIAL QUALITY

Dimension (inches)	Material	Art.-No	Type	Use	Max R.P.M.	
7 x 3/64 x 7/8	▲▲▲	62-0071		CUTTING	8 500	25
7 x 3/64 x 7/8	▲▲▲	62-2771		CUTTING	8 500	25
7 x 3/64 x 7/8	▲▲▲	62-2770		CUTTING	8 500	25
7 x 1/16 x 7/8	▲▲▲	82-0050		CUTTING	8 500	25
7 x 1/16 x 7/8	▲▲▲	62-0716		CUTTING	8 500	25
7 x 1/16 x 7/8	▲▲▲	62-7016		CUTTING	8 500	25
7 x 1/16 x 5/8	▲▲	62-0758		CUTTING	8 500	25
7 x 1/16 x 7/8	▲	52-0004		CUTTING	8 500	50
7 x 1/16 x 7/8	▲	52-2704		CUTTING	8 500	50
7 x 3/32 x 7/8	▲	62-0732		CUTTING	8 500	50
7 x 1/8 x 7/8	▲	52-1300		combined	8 500	50

▲ Steel ▲ SST ▲ Titanium ▲ Cast & PVC ▲ Aluminum

> GRINDING 7"

INDUSTRIAL QUALITY

Dimension (inches)	Material	Art.-No	Type	Use	Max R.P.M.	
7 x 1/4 x 7/8	▲	82-1901		GRINDING	8 500	25
7 x 1/4 x 7/8	▲	82-1900		GRINDING	8 500	25
7 x 1/4 x 7/8	▲	62-1900		GRINDING	8 500	25
7 x 1/4 x 7/8	▲	52-1900		GRINDING	8 500	25

▲ Steel ▲ SST ▲ Titanium ▲ Cast & PVC ▲ Aluminum



- ECONOMIC QUALITY / PRICE
- ECONOMIC QUALITY / PRICE
- GREAT FOR SST



- X-TRA LONG LIFE



CUTTING & GRINDING 8"

INDUSTRIAL QUALITY

Dimension (inches)	Material	Art.-No	Type	Use	Max R.P.M.	
8 x 1/16 x 5/8	▲ Steel ▲ SST ▲ Titanium ▲ Cast & PVC ▲ Aluminum	62-0858		combined	7 600	25

▲ Steel ▲ SST ▲ Titanium ▲ Cast & PVC ▲ Aluminum



CUTTING & GRINDING 9"

INDUSTRIAL QUALITY

Dimension (inches)	Material	Art.-No	Type	Use	Max R.P.M.	
9 x 5/64 x 7/8	▲ Steel ▲ SST ▲ Titanium ▲ Cast & PVC ▲ Concrete ▲ Aluminum	82-0209		CUTTING	6 650	50
9 x 3/32 x 7/8	▲ Steel ▲ SST ▲ Titanium ▲ Cast & PVC ▲ Concrete ▲ Aluminum	62-3209		CUTTING	6 650	50
9 x 1/8 x 7/8	▲ Steel ▲ SST ▲ Titanium ▲ Cast & PVC ▲ Concrete ▲ Aluminum	62-1405		CUTTING	6 650	50

▲ Steel ▲ SST ▲ Titanium ▲ Cast & PVC ▲ Concrete ▲ Aluminum



CUTTING 12" TO 20"

INDUSTRIAL QUALITY

Dimension (inches)	Material	Art.-No	Type	Max R.P.M.	
12 x 3/32 x 1	▲ Steel ▲ SST ▲ Titanium ▲ Cast & PVC ▲ Concrete ▲ Aluminum	82-12F1		5 100	10
14 x 3/32 x 1	▲ Steel ▲ SST ▲ Titanium ▲ Cast & PVC ▲ Concrete ▲ Aluminum	82-14F1		4 400	10
16 x 3/32 x 1	▲ Steel ▲ SST ▲ Titanium ▲ Cast & PVC ▲ Concrete ▲ Aluminum	82-16F1		3 800	10

1 Reinforcement, optimal performance for solid mass parts.

14 x 3/32 x 1	▲ Steel ▲ SST ▲ Titanium ▲ Cast & PVC ▲ Concrete ▲ Aluminum	82-1425		4 400	10
---------------	---	---------	--	-------	----

2 Reinforcements, with optimal performance for empty body parts (tubings).

▲ Steel ▲ SST ▲ Titanium ▲ Cast & PVC ▲ Concrete ▲ Aluminum



Dimension (inches)	Material	Art.-No	Type	Max R.P.M.	
14 x 5/32 x 1	▲ Steel ▲ SST ▲ Titanium ▲ Cast & PVC ▲ Aluminum	82-14A1		5 400	10





▲ Steel ▲ SST ▲ Titanium ▲ Cast & PVC ▲ Aluminum





CUTTING 12" TO 16"

INDUSTRIAL QUALITY

Dimension (inches)	Material	Art.-No	Type	Max R.P.M.	
14 x 1/8 x 1	▲	82-8814		4 400	10
14 x 1/8 x 1	▲	62-8814		4 400	10
16 x 5/32 x 1	▲	82-8816		3 800	10
16 x 5/32 x 1	▲	62-8816		3 800	10

▲ Steel ▲ SST ▲ Titanium ▲ Cast & PVC ▲ Aluminum



▶ VITRIFIED GRINDING WHEELS

META-ROCK VITRIFIED GRINDING & SHARPENING WHEELS

Dimension A x B x C	code	Grit	R.P.M. MAX.	
6 x 3/4 x 1	99-634C	A36 coarse	4 100	1
6 x 3/4 x 1	99-634M	A46 medium	4 100	1
6 x 3/4 x 1	99-634F	A80 Fine	4 100	1
6 x 1 x 1	99-601C	A36 coarse	4 100	1
6 x 1 x 1	99-601M	A46 medium	4 100	1
6 x 1 x 1	99-601F	A80 Fine	4 100	1
7 x 1 x 1	99-701C	A36 coarse	3 600	1
7 x 1 x 1	99-701M	A46 medium	3 600	1
7 x 1 x 1	99-701F	A80 Fine	3 600	1
8 x 3/4 x 1	99-834C	A36 coarse	3 200	1
8 x 3/4 x 1	99-834M	A46 medium	3 200	1
8 x 3/4 x 1	99-834F	A80 Fine	3 200	1
8 x 1 x 1	99-801C	A24 coarse	3 200	1
8 x 1 x 1	99-801M	A46 medium	3 200	1
8 x 1 x 1	99-801F	A80 Fine	3 200	1
8 x 1 1/4 x 1	99-814C	A36 coarse	3 200	1
8 x 1 1/4 x 1	99-814M	A46 medium	3 200	1
8 x 1 1/4 x 1	99-814F	A80 Fine	3 200	1
8 x 7/8 x 1	99-878C	A24 coarse	3 200	1
8 x 7/8 x 1	99-878M	A46 medium	3 200	1
8 x 7/8 x 1	99-878F	A80 Fine	3 200	1
10 x 1 x 1	99-101C	A24 coarse	2 500	1
10 x 1 x 1	99-101F	A80 Fine	2 500	1
10 x 1 1/4 x 1	99-114M	A46 medium	2 500	1
10 x 1 1/4 x 1	99-114F	A80 Fine	2 500	1

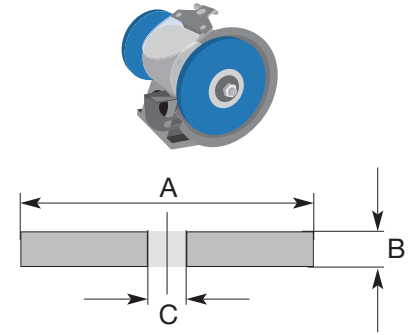

Description: META-ROCK vitrified grinding wheels are made of first quality selected abrasives to offer the best performance in any application. Set of bushings included to fit to shaft diameters 1/2" – 5/8" – 3/4" – 1"

Dimension A x B x C	code	Grit	R.P.M. MAX.	
6 x 3/4 x 1	99-0634	C80 Fine	4 100	1
7 x 1 x 1	99-0701	C80 Fine	3 600	1
7 x 1 1/4 x 1	99-0714	C80 Fine	3 600	1
8 x 7/8 x 1	99-0878	C80 Fine	3 600	1
8 x 1 x 1	99-0801	C80 Fine	3 600	1
8 x 1 1/4 x 1	99-0814	C80 Fine	3 600	1
10 x 1 x 1	99-0010	C80 Fine	2 500	1

Green = CARBURE

Description: META-ROCK carbide vitrified grinding wheels are mainly suitable for sharpening any high density steels. E.G.: Knives, saw blade, bits etc. Set of bushings included to fit to shaft diameters 1/2" – 5/8" – 3/4" – 1"



FLAP DICS WHEELS

- Trimmable support pad of German technology
- Degree of superior removal.
- Deburring discs to meet all requirements.
- The sharp cutting high density zirconium & ceramic flaps allow enhanced stock removal and extremely fast working.
- Exceptional life (up to 25 times better than the competition)



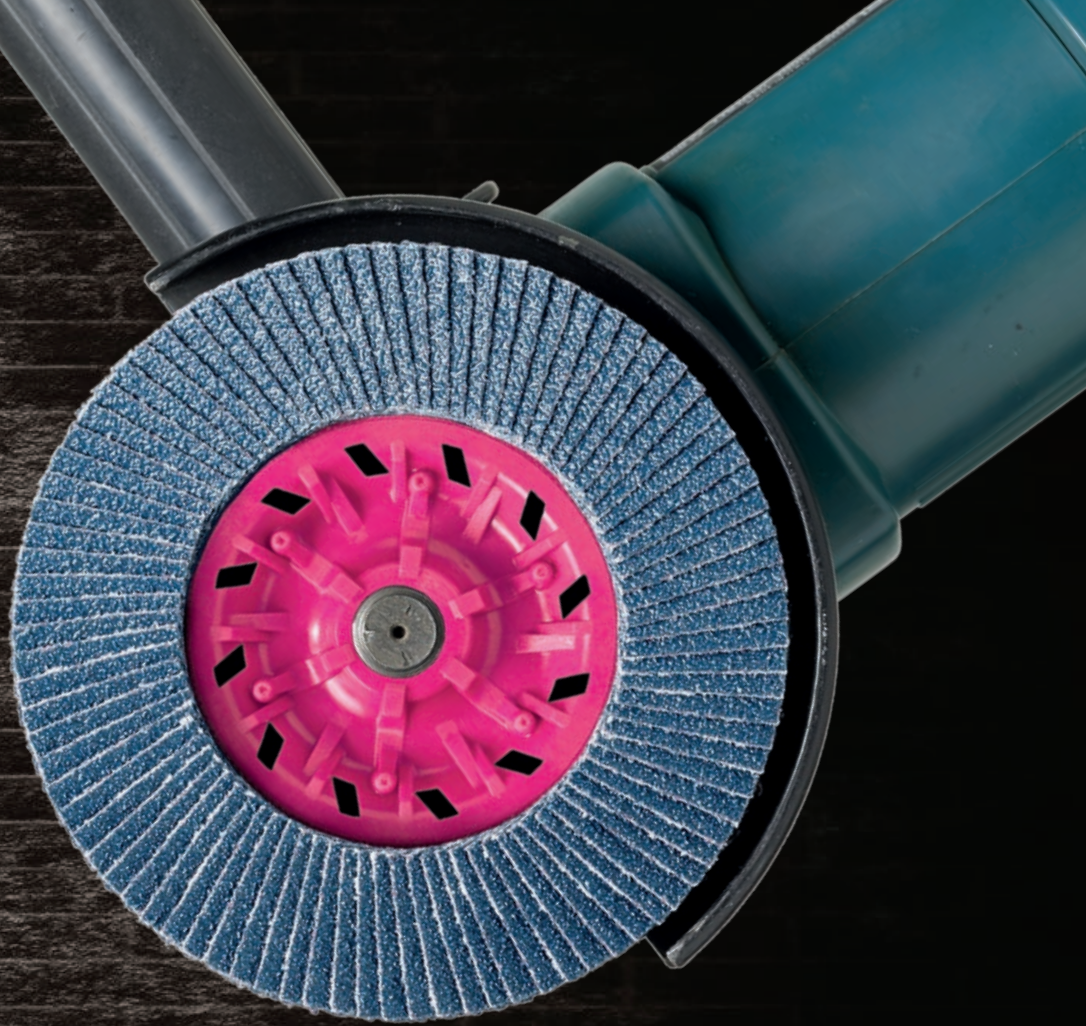

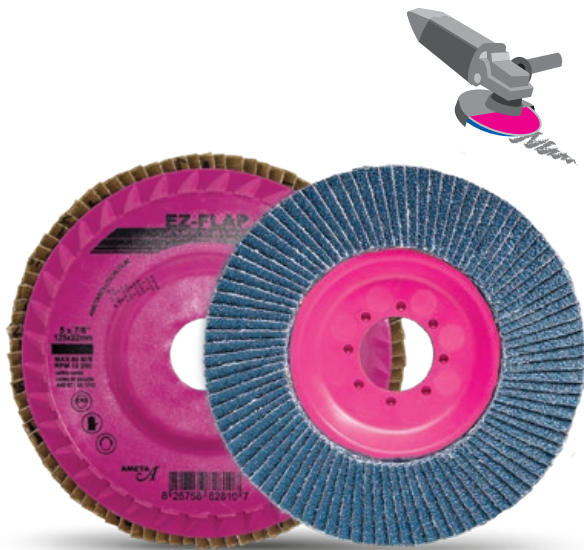

ZIRCONIUM FLAP DISCS-TRIMMABLE

EZ-FLAP TRIMMABLE ZIRCONIUM

Dimension (inches)	Grit	Art.-No	Type	Max R.P.M.	
4 ½ x 7/8	Z-40	82-2800		13 000	10
4 ½ x 7/8	Z-60	82-2801		13 300	10
4 ½ x 7/8	Z-80	82-2802		13 300	10
4 ½ x 7/8	Z-120	82-2803		13 300	10
5 x 7/8	Z-40	82-2810		12 200	10
5 x 7/8	Z-60	82-2811		12 200	10
5 x 7/8	Z-80	82-2812		12 200	10
5 x 7/8	Z-120	82-2813		12 200	10

Description: Professional flap discs with trimmable German high-tech backing pad for high performance removal & maximum productivity.



DID YOU KNOW?

To greatly help prevent frosting of abrasives, and to give them a longer useful life, use abra + 70-30 spray. Also used to avoid overheating during grinding on Steel and SST.



CERAMIC FLAP DISCS-TRIMMABLE











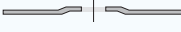

EZ-FLAP TRIMMABLE CERAMIC

Dimension (inches)	Grit	Art.-No	Type	Max R.P.M.	
4 ½ x 7/8	CER-36	82-3800		13 000	10
4 ½ x 7/8	CER-60	82-3801		13 300	10
4 ½ x 7/8	CER-80	82-3802		13 300	10
4 ½ x 7/8	CER-120	82-3803		13 300	10
5 x 7/8	CER-40	82-2600		12 200	10
5 x 7/8	CER-60	82-3811		12 200	10
5 x 7/8	CER-80	82-3812		12 200	10
5 x 7/8	CER-120	82-3813		12 200	10

Description: Professional flap discs with trimmable German high-tech backing pad for superior removal rate and durability (25 times longer than any standard flap discs).

➤ ZIRCONIUM 5/8-11NC TRIMMABLE

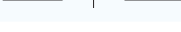
EZ-FLAP TRIMMABLE ZIRCONIUM 5/8-11NC THREADED

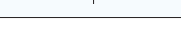
Dimension (inches)	Grit	Art.-No	Type	Max R.P.M.	
4 ½ x 5/8-11nc	Z-40	82-6800		13 000	10
4 ½ x 5/8-11nc	Z-60	82-6801		13 300	10
4 ½ x 5/8-11nc	Z-80	82-6802		13 300	10
4 ½ x 5/8-11nc	Z-120	82-6803		13 300	10
5 x 5/8-11nc	Z-40	82-6810		12 200	10
5 x 5/8-11nc	Z-60	82-6811		12 200	10
5 x 5/8-11nc	Z-80	82-6812		12 200	10
5 x 5/8-11nc	Z-120	82-6813		12 200	10
6 x 5/8-11nc	Z-40	82-6820		10 200	10
6 x 5/8-11nc	Z-60	82-6821		10 200	10
6 x 5/8-11nc	Z-80	82-6822		10 200	10
6 x 5/8-11nc	Z-120	82-6823		10 200	10

Description: Professional flap discs with integral 5/8-11NC threaded trimmable T27 backing pad and advanced turbo air cooling system for best removal & productivity.







DID YOU KNOW?

The integrated advanced turbo air cooling in combination with the sharp cutting high density zirconium flaps allow enhanced stock removal and extremely fast working.



➤ ZIRCONIUM MOBYFLEX

METAFLUX ZIRCONIUM FLAP DISCS

Dimension (inches)	Grit	Art.-No	Type	Max R.P.M.	
4 ½ x 7/8	Z-40	82-2805		13 300	10
4 ½ x 7/8	Z-60	82-2806		13 300	10
4 ½ x 7/8	Z-80	82-2807		13 300	10
5 x 7/8	Z-40	82-2814		12 250	10
5 x 7/8	Z-60	82-2815		12 250	10
5 x 7/8	Z-80	82-2816		12 250	10

Description: Professional flap discs of German technology to meet any professional requirement.





ZIRCONIUM SANDING PAPERS

META-FLEX ZIRCONIUM



Dimension (inches)	Grit	Art.-No	Max R.P.M.	
4 1/2 x 7/8	Z-24	62-4524	13 300	25
4 1/2 x 7/8	Z-36	62-4536	13 300	25
4 1/2 x 7/8	Z-40	62-4540	13 300	25
4 1/2 x 7/8	Z-50	62-4550	13 300	25
4 1/2 x 7/8	Z-60	62-4560	13 300	25
4 1/2 x 7/8	Z-80	62-4580	13 300	25
4 1/2 x 7/8	Z-100	62-4510	13 300	25
5 x 7/8	Z-24	62-0524	12 200	25
5 x 7/8	Z-36	62-0536	12 200	25
5 x 7/8	Z-40	62-0540	12 200	25
5 x 7/8	Z-50	62-0550	12 200	25
5 x 7/8	Z-60	62-0560	12 200	25
5 x 7/8	Z-80	62-0580	12 200	25
5 x 7/8	Z-100	62-5100	12 200	25
5 x 7/8	Z-120	62-5120	12 200	25
7 x 7/8	Z-24	62-0724	8 500	25
9 x 7/8	Z-50	62-0950	6 500	25

Description: Professional Zirconium sanding fiber discs for high performance & productivity.



> CERAMIC SANDING PAPERS

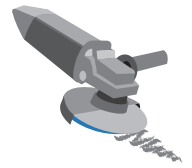

META-FLEX CERAMIC

Dimension (inches)	Grit	Art.-No	Max R.P.M.	
4 1/2 x 7/8	CER-36	63-4536	13 300	25
4 1/2 x 7/8	CER-40	63-4540	13 300	25
4 1/2 x 7/8	CER-50	63-4550	13 300	25
4 1/2 x 7/8	CER-60	63-4560	13 300	25
4 1/2 x 7/8	CER-80	63-4580	13 300	25
5 x 7/8	CER-36	63-0536	12 200	25
5 x 7/8	CER-40	63-0540	12 200	25
5 x 7/8	CER-50	63-0550	12 200	25
5 x 7/8	CER-60	63-0560	12 200	25
5 x 7/8	CER-80	63-0580	12 200	25

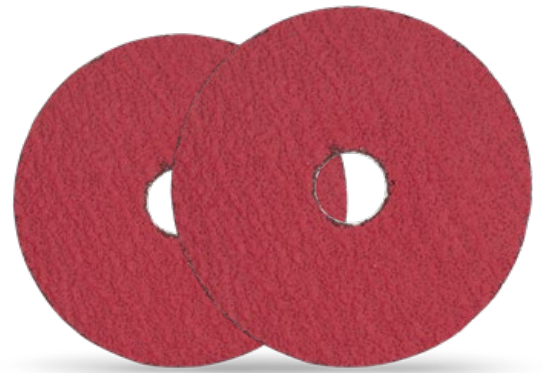

Description: Professional ceramic sanding fiber discs for superior removal rate and durability (25 times sharper than any standard sanding discs).



DID YOU KNOW?

To greatly help prevent frosting of abrasives, and to give them a longer useful life, use abra + 70-30 spray. Also used to avoid overheating during grinding on Steel and SST.



> MOUNTING ACCESSORIES

BACKING PAD & CLAMPING NUT

Dimension (inches)	Art.-No	Description	
4 1/2 x 7/8	66-0045	Backing pad 4 1/2 x 7/8	5
5 x 7/8	66-0005	Backing pad 5 x 7/8	5
7 x 7/8	66-0007	Backing pad 7 x 7/8	5
M10 x 1.25mm	66-0125	Clamping nut for backing pad	10
M10 x 1.50mm	66-0150	Clamping nut for backing pad	10
M10 x 2mm	66-1420	Clamping nut for backing pad	10
5/8-11	66-5811	Clamping nut for backing pad	10



> FLAP WHEELS-1/4" SHAFT

META-FLAP NON-WOVEN

Dimension A x B x C	code	Grit	Max T.P.M.	
2" x 1" x 1/4"	61-2060	60	11 000	10
2" x 1" x 1/4"	61-2080	80	11 000	10
2" x 1" x 1/4"	61-2012	120	11 000	10
2" x 1" x 1/4"	61-2018	180	11 000	10
3" x 1" x 1/4"	61-3060	60	8 000	10
3" x 1" x 1/4"	61-3080	80	8 000	10
3" x 1" x 1/4"	61-3012	120	8 000	10
3" x 1" x 1/4"	61-3018	180	8 000	10
3" x 2" x 1/4"	61-3260	60	8 000	10
3" x 2" x 1/4"	61-3280	80	8 000	10
3" x 2" x 1/4"	61-3212	120	8 000	10
3" x 2" x 1/4"	61-3218	180	8 000	10

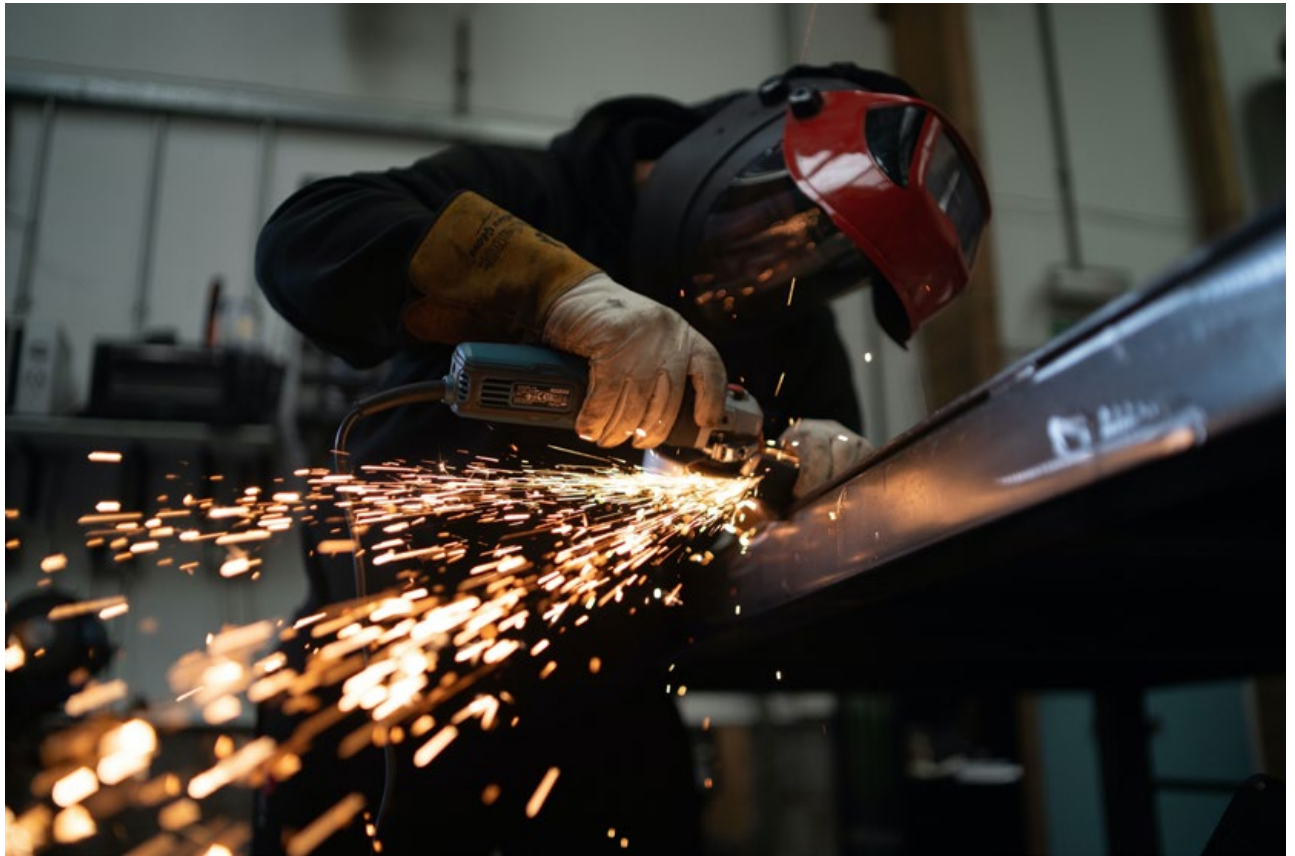
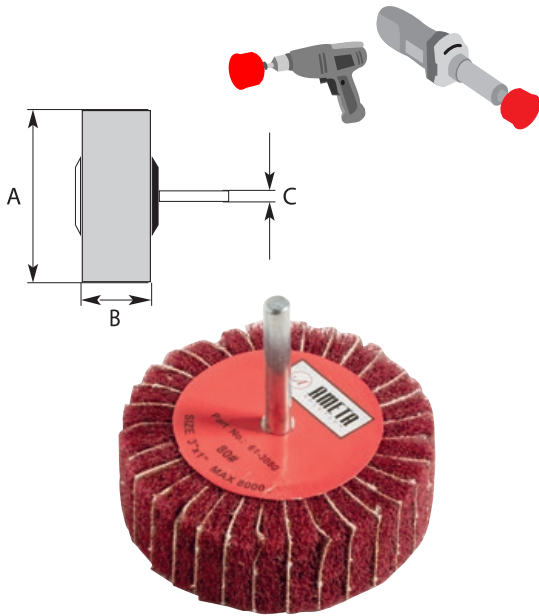

▶ FLAP WHEELS-1/4" SHAFT

META - FLAP ALUMINUM OXIDE

Dimension A x B x C	Art.-No	Grit	Max R.P.M.	
1" x 1" x 1/4"	62-0140	40	30 000	10
1" x 1" x 1/4"	62-0160	60	30 000	10
1" x 1" x 1/4"	62-0180	80	30 000	10
1" x 1" x 1/4"	62-0102	120	30 000	10
1" x 1" x 1/4"	62-0240	240	30 000	10
1 1/2" x 3/8" x 1/4"	62-1128	80	30 000	10
1 1/2" x 3/8" x 1/4"	62-1122	120	30 000	10
1 1/2" x 1" x 1/4"	62-1302	120	30 000	10
1 1/2" x 1" x 1/4"	62-1304	40	30 000	10
1 1/2" x 1" x 1/4"	62-1306	60	30 000	10
1 1/2" x 1" x 1/4"	62-1308	80	30 000	10
2" x 3/8" x 1/4"	62-0206	60	25 000	10
2" x 3/8" x 1/4"	62-0208	80	25 000	10
2" x 3/8" x 1/4"	62-0202	120	25 000	10
2" x 1" x 1/4"	62-2165	40	25 000	10
2" x 1" x 1/4"	62-2166	60	25 000	10
2" x 1" x 1/4"	62-2168	80	25 000	10
2" x 1" x 1/4"	62-2164	240	25 000	10
2 1/2" x 1/2" x 1/4"	62-2106	60	20 000	10
2 1/2" x 1/2" x 1/4"	62-2120	120	20 000	10
2 1/2" x 1/2" x 1/4"	62-2118	180	20 000	10
2 1/2" x 1" x 1/4"	62-2126	60	20 000	10
2 1/2" x 1" x 1/4"	62-2128	80	20 000	10
2 1/2" x 1" x 1/4"	62-2122	120	20 000	10
2 1/2" x 1" x 1/4"	62-2127	180	20 000	10
3" x 1/2" x 1/4"	62-0360	60	20 000	10
3" x 1/2" x 1/4"	62-0311	120	20 000	10
3" x 1/2" x 1/4"	62-0308	180	20 000	10
3" x 1" x 1/4"	62-3040	40	20 000	10
3" x 1" x 1/4"	62-3060	60	20 000	10
3" x 1" x 1/4"	62-3080	80	20 000	10
3" x 1" x 1/4"	62-3180	180	20 000	10
3" x 2" x 1/4"	62-3240	40	20 000	10
3" x 2" x 1/4"	62-3260	60	20 000	10
3" x 2" x 1/4"	62-3280	80	20 000	10

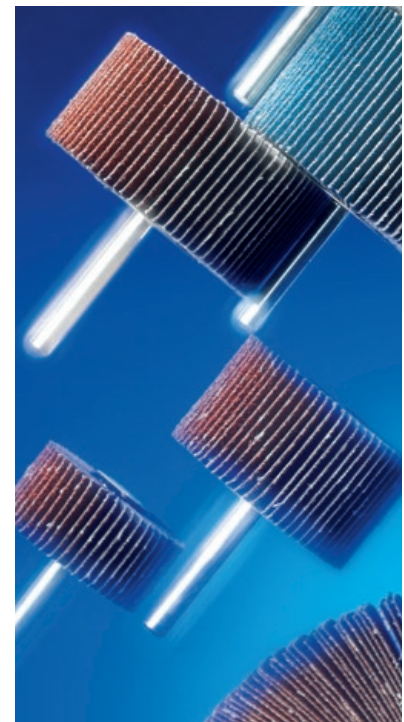
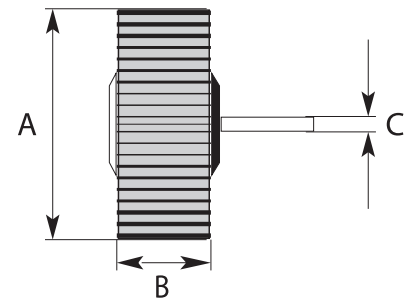

▶ **ALUMINUM OXIDE SANDING ROLLS**

META-SAND



Dimension	code	Grit	
1" x 50 yards	92-6001	60	1
1" x 50 yards	92-8001	80	1
1" x 50 yards	92-1201	120	1
1" x 50 yards	92-1801	180	1
1" x 50 yards	92-2401	240	1
1" x 50 yards	92-3201	320	1
1 ½" x 50 yards	92-6005	60	1
1 ½" x 50 yards	92-8005	80	1
1 ½" x 50 yards	92-1005	100	1
1 ½" x 50 yards	92-1205	120	1
1 ½" x 50 yards	92-1805	180	1
1 ½" x 50 yards	92-2405	240	1
1 ½" x 50 yards	92-3205	320	1
2" x 50 yards	92-8002	80	1
2" x 50 yards	92-1002	100	1
2" x 50 yards	92-1202	120	1
2" x 50 yards	92-1802	180	1
2" x 50 yards	92-2402	240	1
2" x 50 yards	92-3202	320	1

Description: Aluminum oxide quality rolls for general purpose surface sanding. Made of selected abrasive grits on high quality cloth backing in a unique version to provide best performance on metal,

▶ **META-FLEX NON-WOVEN ROLLS**

META-FLEX NON-WOVEN



Dimension	code	Grit	Color	
4" x 30'	84-RMAR	Coarse	Rouge	1
4" x 30'	84-RTAN	Medium	Green	1
4" x 30'	84-RGRE	FIN	Gris	1

Description: Non-woven sanding rolls. Clogging-resistant, water and/or air cleanable rolls for general purpose surface sanding. The non-woven abrasive jumbo rolls are conGreened into smaller rolls according to the desired length. These rolls are extremely flexible and convenient. The excellent sanding performance combined with the resistance to clogging makes them resistant and efficient in removing grease, scale and paints.

META-FLEX NON-WOVEN

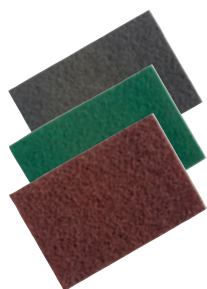

Dimension	code	Grit	Color	
6" x 9"	84-9MAR	Coarse	red	20
6" x 9"	84-9TAN	Medium	green	20
6" x 9"	84-9GRE	FIN	grey	20

Description: Surface conditioning non-woven sanding sheets. Clogging-resistant, water and/or air cleanable sheets for general purpose surface sanding. The non-woven abrasive jumbo rolls are conGreened into convenient precut sheets. These non-woven sheets are extremely flexible and convenient. The excellent sanding performance combined with the resistance to clogging makes them resistant and efficient in removing grease, scale and paints.

➤ ZIRCONIUM FINISHING DISCS LOCK TYPE R

META-LOCK ZIRCONIUM

Dimension	code	Grit	Max R.P.M.	
2"	84-224R	Z-24	30 000	50
2"	84-236R	Z-36	30 000	50
2"	84-260R	Z-60	30 000	50
2"	84-280R	Z-80	30 000	50
2"	84-220R	Z-120	30 000	50
3"	84-324R	Z-24	20 000	25
3"	84-336R	Z-36	20 000	25
3"	84-350R	Z-50	20 000	25
3"	84-360R	Z-60	20 000	25
3"	84-380R	Z-80	20 000	25
3"	84-320R	Z-120	20 000	25

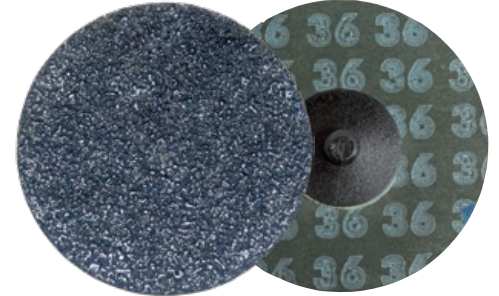

Description: Quick-change zirconium discs with Y weight backing and auto-lock type R system for FINishing operations requiring strong pressure.

i **SHAFT ADAPTOR FOR META-LOCK ZIRCONIUM TYPE R**
 Additional shaft adaptor 2" Order No **84-002R**
 Additional shaft adaptor 3" Order No **84-003R**



➤ CERAMIC FINISHING DISCS LOCK TYPE R

META-LOCK CERAMIC

Dimension	code	Grit	Max R.P.M.	
2"	85-236R	C-36	30 000	50
2"	85-250R	C-50	30 000	50
2"	85-260R	C-60	30 000	50
2"	85-280R	C-80	30 000	50
2"	85-220R	C-120	30 000	50
3"	85-336R	C-36	20 000	25
3"	85-350R	C-50	20 000	25
3"	85-360R	C-60	20 000	25
3"	85-380R	C-80	20 000	25
3"	85-320R	C-120	20 000	25

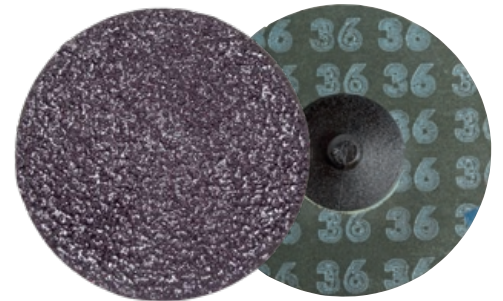

Description: Quick-change enhanced ceramic discs with Y weight backing and auto-lock R system for FINishing operations requiring strong pressure along with superior performance.

i **SHAFT ADAPTOR FOR META-LOCK ZIRCONIUM TYPE R**
 Additional shaft adaptor 2" Order No **84-002R**
 Additional shaft adaptor 3" Order No **84-003R**



FINISHING DISCS-AUTO LOCK TYPE R

META-LOCK CERAMIC TYPE R

Dimension	code	Grit	Max T.P.M.	
2"	85-2CRR	Coarse	23 000	50
2"	85-2MER	Medium	23 000	50
3"	85-3CRR	Coarse	18 000	25
3"	85-3MER	Medium	18 000	25

Description: Quick-change ceramic discs with scrim backing and auto-lock type R system for finishing operations where considerable high mechanical strength is required.

i **SHAFT ADAPTOR FOR META-LOCK CERAMIC TYPE R**
 Additional shaft adaptor 2" Order No **84-002R**
 Additional shaft adaptor 3" Order No **84-003R**



FINISHING DISCS-AUTO LOCK TYPE R

META-LOCK TYPE R

Dimension	code	Grit	Max T.P.M.	
2"	84-2XCR	Extra Coarse (brown)	23 000	50
2"	84-2CRR	Coarse (gold)	23 000	50
2"	84-2MER	Medium (purple)	23 000	50
2"	84-2FIR	Fine (blue)	23 000	50
2"	84-2VFR	Extra Fine (grey)	23 000	50
3"	84-3XCR	Extra Coarse (brown)	18 000	25
3"	84-3CRR	Coarse (gold)	18 000	25
3"	84-3MER	Medium (purple)	18 000	25
3"	84-3FIR	Fine (blue)	18 000	25
3"	84-3VFR	Extra Fine (grey)	18 000	25

Description: Quick-change discs with scrim backing and auto-lock type R system for FINishing operations in hard-to-reach spots.

i **SHAFT ADAPTOR FOR META-LOCK ZIRCONIUM TYPE R**
 Additional shaft adaptor 2" Order No **84-002R**
 Additional shaft adaptor 3" Order No **84-003R**



SCRIM BACK DISCS-TK FASTENING

META TRIM-CUT

Dimension	code	Grit	Max T.P.M.	
3"	84-0024	24	21 000	25*
3"	84-0036	36	21 000	25*
3"	84-0060	60	21 000	25*

Description: Small diameter Finishing discs for applications in hard-to reach spots where considerable high mechanical strength is required. The scrim backing allows high flexibility while the front abrasive coated side works efficiently under heavy pressure. *Adaptor = **84-00TK**

▶ CLEANING DISCS-CENTRAL 1/4" ARBOR HOLE

META-FOAM ROUGE

Dimension	code	optimal R.P.M.	Max R.P.M.	
4" x 1/2" x 1/4"	68-004R	6 000	8 000	10
6" x 1/2" x 1/4"	68-006R	4 100	5 350	10
8" x 1/2" x 1/4"	68-007R	2 800	4 000	10

Description: Red nylon cleaning discs with central 1/4" hole for additional shaft mounting. Intended for efficient surface cleaning and paint removal. Long-life is secured in any heavy-duty mechanical surface cleaning process.

i **Shaft adaptor – ACCESSORIES**
Shaft adaptor No **68-001A** (1") & **84-002A** (2")

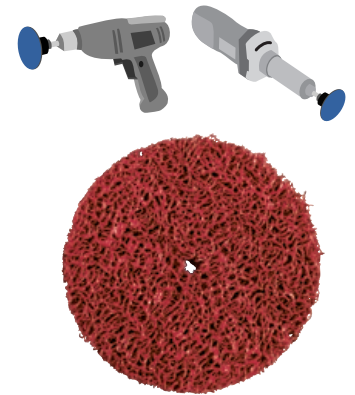

▶ CLEANING DISCS LOCK TYPE R

META-FOAM PURPLE

Dimension	code	optimale R.P.M.	Max R.P.M.	
3"	82-0030	6 000	8 000	10

Description: These discs are made from a tough synthetic fibre impregnated with silicon carbide abrasive grit. Silicon carbide is designed for stone, terrazzo, ceramic and non-ferrous metal.

The highest quality silicon carbide grain is selected for this disc. They are a safer alternative to wire bristle tools. These unique discs provide fast cutting action with virtually no heat build-up. The open coat design quickly cleans surfaces without damage.

i **SHAFT ADAPTOR FOR META-FOAM PURPLE TYPE R**
Additional shaft adaptor 3" Order No **84-003R**



▶ CLEANING DISCS-7/8" HOLE

META-FOAM RED

Dimension	code	optimale T.P.M.	Max T.P.M.	
4 1/2" x 7/8"	68-045R	8 600	11 000	
5" x 7/8"	68-050R	7 800	9 800	10
7" x 7/8"	68-070R	5 600	7 000	10

Description: Red nylon cleaning discs mounted on T27 backing pad for efficient surface cleaning and paint removal. Long-life is secured in any heavy-duty mechanical surface cleaning process, such as oxidation and scale removal, cleaning of welded joints, etc. Clogging materials like salt, grease, oil and protective wax layers are efficiently removed with maximum efficiency.

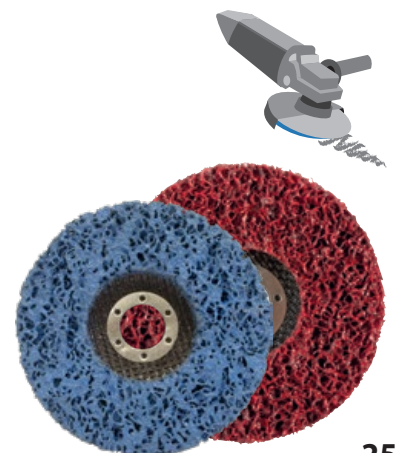



AMETA

BRUSHES

- Comply with the strictest industrial standards.
- Superior degree of removal.
- Superior quality to meet all requirements.
- All brushes carry the Ameta warranty.
- Exceptional life span





▶ **KNOTTED STEEL WIRE CUP**

72/62 KW-AG CUP BRUSHES FOR ANGLE GRINDERS

Arbor	Type	Art.-No	Wire	Diameter	Max R.P.M.	
M10 x 1.5	knotted	72-3000	.020"	3"	12 500	5
M14 x 2.0	knotted	72-3001	.020"	3"	12 500	5
5/8"-11nc	knotted	72-3002	.020"	3"	12 500	5
M10 x 1.25	knotted	72-3003	.020"	3"	12 500	5

Red brushes = Steel

Arbor	Type	Art.-No	Wire	Diameter	Max R.P.M.	
M14 x 2.0	knotted	62-3001	.020"	3"	12 500	25
5/8"-11nc	knotted	62-3002	.020"	3"	12 500	25

Blue brushes = for SST & Alu

Description: Knotted Steel Wire Cup Brushes comply with the strictest industrial standards. Intended for heavy duty cleaning jobs, stripping welds, cleaning weld toes and removal of heavy rust or corrosion, peinture, etc.



DID YOU KNOW?

Each brush carries the Ameta guarantee.

▶ **KNOTTED STEEL WIRE CUP WITH RING**

72/62 KW-AG CUP BRUSHES WITH RING FOR ANGLE GRINDERS

Arbor	Type	Art.-No	Wire	Diameter	Max R.P.M.	
M14 x 2.0	knotted	72-1300	.020"	3"	12 500	5
5/8"-11nc	knotted	72-1301	.020"	3"	12 500	5
5/8"-11nc	knotted	72-1400	.020"	4"	8 500	5
5/8"-11nc	knotted	72-1500	.020"	5"	6 500	5

Red brushes = Steel

Arbor	Type	Art.-No	Wire	Diameter	Max R.P.M.	
M14 x 2.0	knotted	62-1300A	.020"	3"	12 500	5
5/8"-11nc	knotted	62-1301	.020"	3"	12 500	5
5/8"-11nc	knotted	62-1400	.020"	4"	8 500	5
5/8"-11nc	knotted	62-1500	.020"	5"	6 500	5

Blue brushes = for SST & Alu

Description: Knotted Wire Cup Brushes with Ring provide the same features like the standard cup brushes with an additional removable ring. The ring prevents the distortion of wires and increases the effective life span of the brush. Once the wires are worn out up to the ring, the user can easily remove it to loosen the rest of the brush wires. This feature enhances safety and performance. Each brush carries the



Convert Your Brush Threads with These Adapters:

72-1001: 5/8"-11nc to M10 x 1.25

72-1002: 5/8"-11nc to M10 x 1.5

72-1003: M14 x 2.0 to M10 x 1.25

72-1004: M14 x 2.0 to M10 x 1.5



► CRIMPED STEEL WIRE CUP

72/62 CW-AG CUP BRUSHES FOR ANGLE GRINDERS

Arbor	Type	Art.-No	Wire	Diameter	Max R.P.M.	
M14 x 2.0	crimped	72-0030	.014"	3"	12 500	5
5/8"-11nc	crimped	72-0031	.014"	3"	12 500	5
5/8"-11nc	crimped	72-0040	.014"	4"	8 500	5
5/8"-11nc	crimped	72-0050	.014"	5"	6 500	5

Red brushes = Steel

Arbor	Type	Art.-No	Wire	Diameter	Max R.P.M.	
M14 x 2.0	crimped	62-0030	.0118"	3"	12 500	5
5/8"-11nc	crimped	62-0031	.0118"	3"	12 500	5
5/8"-11nc	crimped	62-0040	.020"	4"	8 500	5
5/8"-11nc	crimped	62-0050	.014"	5"	6 500	5

Blue brushes = for SST & Alu

Description: Crimped Steel Wire Cup Brushes for steel are made of top quality piano steel wire which significantly reduces the heat generated by friction, thus expanding the life span at the same time. These brushes are especially recommended for light surface cleaning such as the removal of paint and rust. Crimped steel wire brushes are softer and more flexible than the knotted steel wire brushes. Each brush carries the Ameta guarantee.



► KNOTTED STEEL WIRE BEVEL BRUSHES

72/62 KW-AG BEVEL BRUSHES (T28) FOR ANGLE GRINDERS

Arbor	Type	Art.-No	Wire	Diameter	Max R.P.M.	
M14 x 2.0	knotted	72-4500	.020"	4 1/2"	12 500	5
5/8"-11nc	knotted	72-4501	.020"	4 1/2"	12 500	5
M14 x 2.0	knotted	72-5500	.020"	5"	12 500	5
5/8"-11nc	knotted	72-5501	.020"	5"	12 500	5

Red brushes = Steel

Arbor	Type	Art.-No	Wire	Diameter	Max R.P.M.	
5/8"-11nc	knotted	62-4501	.020"	4 1/2"	12 500	5
M14 x 2.0	knotted	62-5500	.020"	5"	12 500	5
5/8"-11nc	knotted	62-5501	.020"	5"	12 500	5

Blue brushes = for SST & Alu

Description: These brushes combine the advantages of metal brushes and cup brushes. The cone shape allows to work in hard-to-reach spots such as angles and corners. Ideal for cleaning welds and removal of rust, paint, etc. Each brush carries the Ameta guarantee.



▶ TWISTED STEEL WIRE WHEEL BRUSHES

72/62 KW-AG WHEEL BRUSHES FOR ANGLE GRINDERS

Arbor	Type	Art.-No	Wire	Dia.	Width	Max R.P.M.	
5/8"-11nc	twisted	72-4440	.020"	4"	3/16"	20 000	1
5/8"-11nc	twisted	72-4445	.020"	4 1/2"	3/16"	15 000	1
5/8"-11nc	twisted	72-4450	.020"	5"	1/4"	15 000	1
5/8"-11nc	twisted	72-4460	.020"	6"	1/4"	12 000	1

SERIES 72 = Steel

5/8"-11nc	twisted	62-4440	.020"	4"	3/16"	20 000	1
5/8"-11nc	twisted	62-4445	.020"	4 1/2"	3/16"	15 000	1
5/8"-11nc	twisted	62-4450	.020"	5"	1/4"	15 000	1
5/8"-11nc	twisted	62-4460	.020"	6"	1/4"	12 000	1

SERIES 62 = SST & Aluminum

▶ KNOTTED STEEL WIRE WHEEL BRUSHES

72/62 KW-AG WHEEL BRUSHES FOR ANGLE GRINDERS

Arbor	Type	Art.-No	Wire	Dia.	Width	Max R.P.M.	
5/8"-11nc	knotted	72-6440	.020"	4"	1/4"	20 000	1
5/8"-11nc	knotted	72-6445	.020"	4 1/2"	1/4"	15 000	1
5/8"-11nc	knotted	72-6450	.020"	5"	3/8"	15 000	1
5/8"-11nc	knotted	72-6460	.020"	6"	3/8"	12 000	1

SERIES 72 = Steel

5/8"-11nc	knotted	62-6440	.020"	4"	1/4"	20 000	1
5/8"-11nc	knotted	62-6445	.020"	4 1/2"	1/4"	15 000	1
5/8"-11nc	knotted	62-6450	.020"	5"	3/8"	15 000	1
5/8"-11nc	knotted	62-6460	.020"	6"	3/8"	12 000	1

SERIES 62 = SST & Aluminum

Description: Knotted Steel Wire Wheel Brushes for general purpose cleaning applications. Made for use on angle grinders. Each brush carries the Ameta guarantee. Ameta.

▶ CRIMPED STEEL WIRE WHEEL

72 CW-BG WHEEL BRUSHES FOR BENCH GRINDERS

Arbor	Type	Art.-No	Wire	Dia.	Width	Max R.P.M.	
1/2" to 5/8"	crimped	72-5000	.0118"	5"	3/4"	8 500	5
1/2" to 1"	crimped	72-6000	.0118"	6"	7/8"	6 000	5
1/2" to 1"	crimped	72-8000	.0118"	8"	1"	4 500	5
1/2" to 1"	crimped	72-1000	.0118"	10"	1"	3 600	5

Description: Crimped Steel Wire brushes for bench grinders are supplied with a set of bushings to fit the following shaft diameters: 1/2", 5/8", 3/4" and 1".



Convert Your Brush Threads with These Adapters:

- 72-1001: 5/8"-11nc to M10 x 1.25
- 72-1002: 5/8"-11nc to M10 x 1.5
- 72-1003: M14 x 2.0 to M10 x 1.25
- 72-1004: M14 x 2.0 to M10 x 1.5

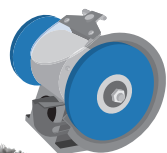

> KNOTTED STEEL WIRE WHEEL

72 B WHEEL BRUSHES FOR ANGLE AND BENCH GRINDERS

Arbor	Type	Art.-No	Wire	Dia.	Width	Max R.P.M.	
7/8"	knotted	72-600T	.020"	6"	1/2"	9 000	5
7/8"	knotted	72-800T	.020"	8"	1/2"	8 500	5

SERIES 72 = Steel

Description: Knotted wheel brushes for the removal of welding toes, rust and paint. Each brush carries the Ameta guarantee.

> KNOTTED STEEL WIRE WHEEL

72 H WHEEL BRUSHES FOR DIE GRINDERS

Arbor	Type	Art.-No	Wire	Dia.	Width	Max R.P.M.	
3/8-1/2"	knotted	72-0003	.014"	3"	3/8"	25 000	5
3/8-5/8"	knotted	72-0002	.014"	4"	3/8"	20 000	5

SERIES 72 = Steel

Description: Specially made for applications in the automotive field to remove rust and paint from wheel rims, car body and other details. Can be used on straight or angle die grinders.

> KNOTTED STEEL WIRE WHEEL

72 S WHEEL BRUSHES FOR DIE GRINDERS

Arbor	Type	Art.-No	Wire	Dia.	Width	Max R.P.M.	
1/4"	knotted	72-0001B	.014"	3"	3/8"	25 000	12
1/4"	knotted	72-0002B	.014"	4"	3/8"	12 500	12

SERIES 72 = Steel

Description: Specially made for applications in the automotive field to remove rust and paint from wheel rims, car body and other details. Can be used on straight or angle die grinders. Each brush carries the Ameta guarantee.

> CRIMPED STEEL WIRE LINEAR

72/62 LINEAR BRUSHES MANUAL AND JIGSAW

Type	Type	Art.-No	Wire	Long.	Width	
plastic brown	crimped	72-4901	.0118"	6.5"	3/8"	12
plastic brown	crimped	72-4938	.0118"	6.7"	1"	12
plastic red	crimped	72-0010	.0118"	10.4"	1"	12
metal black	crimped	72-1310	.0118"	8.6"	1"	12
wood	crimped	72-0009	.0118"	10.4"	1"	12

SERIES 72 = Steel

plastic green	crimped	62-0010A	.0118"	10.4"	1"	12
---------------	---------	-----------------	--------	-------	----	----

SERIES 62 = SST & Aluminum

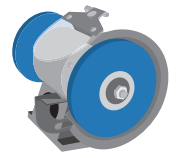

ADAPTOR FOR 2" & 3" ABRASIVES

72-000A: 3/8" SHAFT BLACK

72-000B: 1/4" SHAFT GOLD
Allows any die grinder or drill to be turned into a cut-off tool using either 1/4" or 3/8" I.D. Cut-Off wheels.



▶ **KNOTTED & CRIMPED WIRE BRUSHES 1/4"**

ASSORTED KNOTTED & CRIMPED WIRE BRUSHES ON 1/4" SHAFT



Arbor	Type	Art.-No	Wire Dia.	Use	Max R.P.M.	
1/4"	knotted	72-4001	.20" 1 1/8"	▲	20 000	20
1/4"	knotted	62-4001	.20" 1 1/8"	▲ ▲	20 000	20

▲ Steel ▲ SST ▲ Aluminum



Arbor	Type	Art.-No	Wire Dia.	Use	Max R.P.M.	
1/4"	knotted	72-4002	.20" 3"	▲	20 000	12
1/4"	knotted	72-4003	.20" 4"	▲	20 000	12

▲ Steel ▲ SST ▲ Aluminum



Arbor	Type	Art.-No	Wire Dia.	Use	Max R.P.M.	
1/4"	crimped	72-4110	.010" 1/2"	▲	20 000	20
1/4"	crimped	72-4120	.020" 1/2"	▲	20 000	20
1/4"	crimped	72-4004	.014" 3/4"	▲	20 000	20
1/4"	crimped	72-4005	.014" 1"	▲	20 000	20
1/4"	crimped	62-4110	.010" 1/2"	▲ ▲	20 000	20
1/4"	crimped	62-4120	.020" 1/2"	▲ ▲	20 000	20
1/4"	crimped	62-4004	.014" 3/4"	▲ ▲	20 000	20

▲ Steel ▲ SST ▲ Aluminum



Arbor	Type	Art.-No	Wire Dia.	Use	Max R.P.M.	
1/4"	crimped	72-4106	.008" 1 1/2"	▲	20 000	12
1/4"	crimped	72-4006A	.0118" 2"	▲	20 000	12
1/4"	crimped	72-4007A	.0118" 3"	▲	20 000	12
1/4"	crimped	62-4106	.008" 1 1/2"	▲ ▲	20 000	12
1/4"	crimped	62-4006A	.0118" 2"	▲ ▲	20 000	12
1/4"	crimped	62-4007A	.0118" 3"	▲ ▲	20 000	12

▲ Steel ▲ SST ▲ Aluminum



Arbor	Type	Art.-No	Wire Dia.	Use	Max R.P.M.	
1/4"	crimped	72-4006	.014" 2"	▲	20 000	12
1/4"	crimped	72-4007	.014" 3"	▲	10 000	12

▲ Steel ▲ SST ▲ Aluminum



Arbor	Type	Art.-No	Wire Dia.	Use	Max R.P.M.	
1/4"	crimped	72-4008	.0118" 1 1/2"	▲	10 000	12
1/4"	crimped	72-4009	.0118" 2 1/2"	▲	10 000	12

▲ Steel ▲ SST ▲ Aluminum

▶ **KNOTTED WIRE BRUSHES 1/4"**

ASSORTED KNOTTED WIRE BRUSHES ON 1/4" SHAFT

Arbor	Type	Art.-No	Wire Dia.	Use	Max R.P.M.	
1/4"	knotted	72-7902	.020"	3"	▲ 12 500	12

▲ Steel ▲ SST ▲ Aluminum

Knotted Steel Wire Wheel Brushes for general purpose cleaning applications. Made for use on angle grinders. Each brush carries the Ameta

Arbor	Type	Art.-No	Wire Dia.	Use	Max R.P.M.	
1/4"	knotted	72-7901	.020"	3"	▲ 12 500	12

▲ Steel ▲ SST ▲ Aluminum



▶ **TWISTED STEEL WIRE SPIRAL BRUSHES**

72 TW SPIRAL BRUSHES FOR PIPE CLEANING

Dimension A x B x C	Type	Art.-No	Wire	
5/8" x 4" x 6 1/4"	1/4"- mâle	72-7701	.008"	20
3/4" x 4" x 6 1/4"	1/4"- mâle	72-7702	.008"	20
1" x 4" x 6 1/4"	1/2"- mâle	72-7703	.012"	20
1 1/4" x 4" x 6 1/4"	1/2"- mâle	72-7704	.012"	20
1 1/2" x 4" x 6 1/4"	1/2"- mâle	72-7705	.012"	20
2" x 4" x 6 1/4"	1/2"- mâle	72-7706	.012"	20
2 1/2" x 4" x 6 1/4"	1/2"- mâle	72-7707	.012"	20

Galvanised Steel

Dimension A x B x C	Type	Art.-No	Wire	
1" x 4" x 7 1/2"	1/2"- mâle	72-7603	.012"	20
5/8" x 3 1/4" x 5 1/2"	5/16-18- mâle	72-7601	.008"	20

Galvanised Steel

Dimension A x B x C	Type	Art.-No	Wire	
1/2" x 3 1/2" x 5 1/2"	1/4"- mâle	72-7503	.006"	20
3/4" x 2 1/2" x 4"	5/16-18 - mâle	72-7501	.006"	20

Brass

Dimension A x B x C	Type	Art.-No	Wire	
5/16" x 2 1/2" x 4"	3/16-24 - mâle	72-7801	.006"	20

Brass

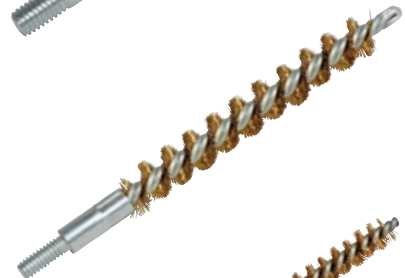
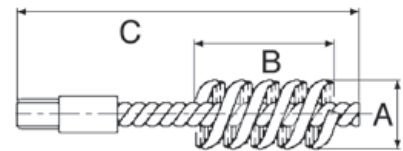

➤ **META-POLISH 1/4" SHAFT**

POLISHING COTTON



Dimension	code	Material	Max T.P.M.	
3" x 3/8" x 1/4"	45-003R	Cotton	4 500	10
4" x 3/8" x 1/4"	45-004R	Cotton	4 500	10

Description: For high quality final surface finishing operations. Made of top quality cotton, the Meta Polish wheels on shaft are highly recommended to the following industrial fields: chemical and food plants, stainless steel furniture, automotive, railways, aeronautic, stainless steel and structural constructions.

➤ **META-POLISH 1/4" SHAFT**

POLISHING COTTON



Dimension	code	Material	Max T.P.M.	
3" x 1/2" x 1/4"	45-0003	Cotton	4 500	10
4" x 1/2" x 1/4"	45-0004	Cotton	4 500	10

Description: For high quality final surface finishing operations. Made of top quality cotton, the Meta Polish wheels on shaft are highly recommended to the following industrial fields: chemical and food plants, stainless steel furniture, automotive, railways, aeronautic, stainless steel and structural constructions.

➤ **META-POLISH 1/4" SHAFT**

POLISHING COTTON



Dimension	code	Material	Max T.P.M.	
2" x 2 1/2" x 1/4"	45-0202	Cotton	4 500	10
2 1/2" x 2 1/2" x 1/4"	45-2121	Cotton	4 500	10

Description: For high quality final surface finishing operations. Made of top quality cotton, the Meta Polish wheels on shaft are highly recommended to the following industrial fields: chemical and food plants, stainless steel furniture, automotive, railways, aeronautic, stainless steel and structural constructions.

➤ **META-POLISH 1/4" SHAFT**

POLISHING COTTON



Dimension	code	Material	Max T.P.M.	
1 1/2" x 2" x 1/4"	45-0002	Cotton	4 500	10
2 1/2" x 2 1/2" x 1/4"	45-0021	Cotton	4 500	10

Description: For high quality final surface finishing operations. Made of top quality cotton, the Meta Polish wheels on shaft are highly recommended to the following industrial fields: chemical and food plants, stainless steel furniture, automotive, railways, aeronautic, stainless steel and structural constructions.

▶ META-POLISH 1/4" SHAFT KIT



POLISHING COTTON KIT

Shaft	Art.-No	Material	Grit	
Meta-polish set	45-000K	cotton	medium	10
Unit	45-0010	cotton	medium	10
Unit	45-0011	cotton	medium	10
Unit	45-0012	cotton	medium	10
Unit	45-0013	cotton	medium	10
Unit	45-0014	cotton	medium	10
Unit	45-0015	cotton	medium	10



Description: 6-PIECES KIT for high quality final surface finishing operations. Made of top quality cotton, the Meta Polish wheels on shaft are highly recommended to the following industrial fields: chemical and food plants, stainless steel furniture, automotive, railways, aeronautic, stainless steel and structural constructions.

▶ META-POLISH ARBOR 5/8"

POLISHING COTTON

Dimension	Art.-No	Material	Grit	
4" x 1/2" x 5/8"	45-004M	cotton	Medium	10
4" x 1/2" x 5/8"	45-004G	cotton	Hard	10
6" x 1/2" x 5/8"	45-006M	cotton	Medium	10
6" x 1/2" x 5/8"	45-006G	cotton	Ferme	10
8" x 1/2" x 5/8"	45-008M	cotton	Medium	10
8" x 1/2" x 5/8"	45-008G	cotton	Hard	10



▶ META-POLISH ARBOR 5/8"

POLISHING COTTON

Dimension	Art.-No	Material	Grit	
5" x 5/8"	45-500V	cotton	Hard	10



▶ META-POLISH 5/8" 11-NC

POLISHING COTTON

Dimension	Art.-No	Material	Grit	
4.5" x 5/8" 11NC	45-4558	cotton	Hard	10



Description: For high quality final surface finishing operations. Made of top quality cotton, the Meta Polish wheels on shaft are highly recommended to the following industrial fields: chemical and food plants, stainless steel furniture, automotive, railways, aeronautic, stainless steel and structural constructions.

▶ POLISHING PASTES

TUBE 110 G [3.88 OZ.]



Color	Art.-No	Description	Quantity	
White	45-1000	Clean and polish Sscard	110 g [3.88 oz.]	10
Green	45-2000	Clean and polish Ssxcard	110 g [3.88 oz.]	10
Blue	45-3000	Clean and polish Multishine	110 g [3.88 oz.]	10
Brown	45-4000	Clean and polish Tripoly	110 g [3.88 oz.]	10
Grey	45-5000	Clean and polish Fastcut	110 g [3.88 oz.]	10
Black	45-6000	Clean and polish Hard Metal	110 g [3.88 oz.]	10

Description: Polishing pastes in different grades for high quality FINal FINishing. A selection of carded polishing pastes to be used in combination with Meta-Polish discs and wheels on shaft according to the desired application:

Paste No. 1 white (45-1000) for steel, chrome, nickel and other alloys. Minimum polishing required.

Paste No 2 green (45-2000) for tools, molds and medical instruments. Excellent for stainless steel and non-ferrous metal.

Paste No 3 blue (45-3000) for mirror-like FINish on any metal. Excellent for stainless steel, brass, copper, lacquer, plastic and acrylic.

Paste No 4 blue (45-4000) super FINE abrasive stiff grease paste for mirror-like FINish. Excellent for jewelry, silver, platinum, brass and aluminum.

Paste No. 5 gray (45-5000) fast cutting. Excellent for plastic, non-ferrous metal, compounds and wood.

Paste No. 6 black (45-6000) fast cutting and aggressive action on deep scratches. Excellent for steel, stainless steel, nickel and chrome.



Color/Grit	Art.-No	Description	Finish	
Green/medium	76-2025	green polish 250ml	shining	25
Green/medium	76-2001	green polish 960ml.	shining	12
Green/medium	76-2004	green polish 4000ml.	shining	4



Color/Grit	Art.-No	Description	Finish	
White/Fine	76-2125	white polish 250ml	ultra shining	25
White/Fine	76-2101	white polish 960ml.	ultra shining	12
White/Fine	76-2104	white polish 4000ml.	ultra shining	4

Description: High performance liquid polish paste specifically made for professional cleaning and polishing of aluminum, magnesium and stainless steel surfaces. Intended for professional cleaning and polishing of aluminum, magnesium and stainless steel . Excellent for alloy wheel rims. Shake well before use. Pour a small quantity of product on a buffer and rub it on the selected area in circular clockwise direction. A clean cotton cloth will help to remove excessive polish from the surface.

- Easy to use and very economical
- Ready to use
- No electric buffer polisher required
- Manual application



Color	Art.-No	Description	type	
White	76-9701	polymere & carnauba wax	paste	12
White	76-9704	polymere & carnauba wax	paste	4
White	76-9720	polymere & carnauba wax	paste	1



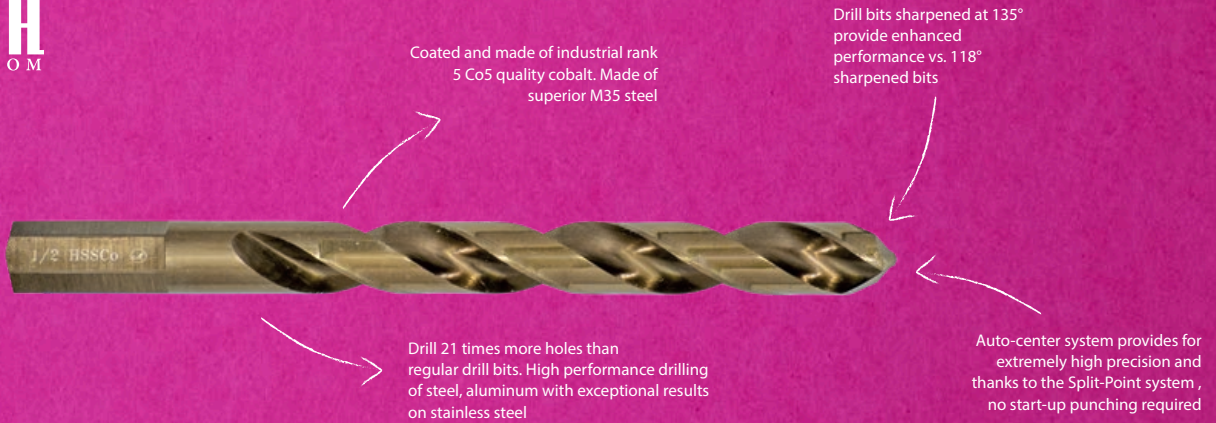

RECOMMENDED:

Use METAFUX tool spray and increase drillbits life up to 100%...



NEW!

Unlike traditional drill bits made from steel rods, our 44 HEX-PRESS series is crafted from steel powder.

This powder is then heavily compressed using specially designed presses, resulting in our 44 HEX-PRESS series.

AVAILABLE SIZES:
1/16" TO 1/2" BY 64"



	Material															
	Low	Med	High	4140 4340	Die Steels	300	400	17-4 PH	Cast Iron	6061 7075	Casting	Inconel	6Al4V (30 HRC)	≈ 35 HRC	35-45 HRC	45-50 HRC
	Carbon Steels			Allow Steels		Stainless steel				Aluminum		Nickel Alloy	Titanium	Hardened Steels		
Cobalt serie	*****	*****	***	*****	*****	*****	***	***	***	*	***	*	*	***	*	*
TiCN serie 44	***	*****	*****	*****	*****	***	***	***	*****	***	***	*****	***	*****	*****	***

HIGH PERFORMANCE DRILLBITS

Which one to get?



HEX-PRESS

Made from a fusion of a single powder alloy, highly pressurized. Covered with multiple layers of TiCN (Titanium Carbo-nitride).



COBALT CO5

Coated and made of industrial rank 5 Co5 quality cobalt.
Made of superior M35 steel



BLACK & GOLD

Bronze oxide coating for additional tempering and stress relief allowing greater durability.

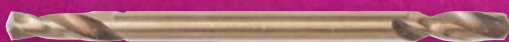

DOUBLE-END

Double ended drill bits offer incomparable strength and increased flexibility, thus expanding their life span by up to 65%.



ROUNDED SHAFT

Rounded shank for additional tempering and stress relief



6-FLAT SHAFT

6-face shank design for tight chuck grip

HEX
SYSTEM
TWIST & LOCK

NOUVEAU



HEX-PRESS DRILLBITS FRACTIONNAL

SERIES 44 / HEX-PRESS TiCN PRESSURIZED

Diam.	code	Lenght spiral	Total lenght	Shaft		Diam.	code	Lenght spiral	Total lenght	Shaft	
1/16	44-0116	7/8	1-7/8	Round	10	19/64	44-1964	3-1/16	4-3/8	hex	5
5/64	44-0564	1	2	Round	10	5/16	44-0516	3-3/16	4-1/2	hex	5
3/32	44-0332	1-1/4	2-1/4	Round	10	21/64	44-2164	3-5/16	4-5/8	hex	5
7/64	44-0764	1-1/2	2-5/8	Round	10	11/32	44-1132	3-7/16	4-3/4	hex	5
1/8	44-0018	1-5/8	2-3/4	Round	10	23/64	44-2364	3-1/2	4-7/8	hex	5
9/64	44-0964	1-3/4	2-7/8	Round	10	3/8	44-0038	3-5/8	5	hex	5
5/32	44-0532	2	3-1/8	Round	10	25/64	44-2564	3-3/4	5-1/8	hex	5
11/64	44-1164	2-1/8	3-1/4	Round	10	13/32	44-1332	3-7/8	5-1/4	hex	5
3/16	44-0316	2-5/16	3-1/2	hex	10	27/64	44-2764	3-15/16	5-3/8	hex	5
13/64	44-1364	2-7/16	3-5/8	hex	10	7/16	44-0716	4-1/16	5-1/2	hex	5
7/32	44-0732	2-1/2	3-3/4	hex	10	29/64	44-2964	4-3/16	5-5/8	hex	5
15/64	44-1564	2-5/8	3-3/7	hex	10	15/32	44-1532	4-5/16	5-3/4	hex	5
1/4	44-0014	2-3/4	4	hex	10	31/64	44-3164	4-3/8	5-7/8	hex	5
17/64	44-1764	2-7/8	4-1/8	hex	10	1/2	44-0012	4-1/2	6	hex	5
9/32	44-0932	2-15/16	4-1/4	hex	10						

Description: HEX-PRESS TiCN pressurized drills are manufactured using advanced technology, utilizing a high-quality metal alloy that is carefully prepared to ensure outstanding performance. These drills are designed to exceed typical standards, providing unmatched durability and efficiency. The sharpened tip at 135 degrees ensures greater longevity. Coated with multiple layers of TiCN, giving them a distinctive grayish-purple appearance and enhancing the hardness of the drills, making them less likely to break.

FRACTIONNAL DRILLBITS KITS SERIES-44

Total of Bits	code	Dimension	Kit type	Bits type
29	44-0001	1/16" to 1/2" by 64"	Steel	TiCN
29	44-0001P	1/16" to 1/2" by 64"	Plastic	TiCN
21	44-0004	1/16" to 3/8" by 64"	Steel	TiCN
15	44-0002	1/16" to 1/2" by 32"	Steel	TiCN
13	44-0003	1/16" to 1/4" by 64"	Steel	TiCN



DRILLBITS BLACK & GOLD FRACTIONAL

SERIE 33 / COBALT DRILLBITS HEX AND ROUND SHAFT

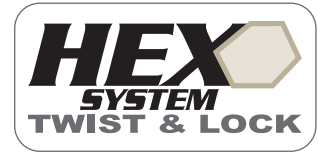

Diam.	code	spiral length	total length	shaft		Diam.	code	spiral length	total length	shaft	
3/64	33-0364	25/32	1-47/64	Round	10	21/64	33-2164	3-5/16	4-5/8	HEX	5
1/16	33-0116	7/8	1-7/8	Round	10	21/64	33-2164R	3-5/16	4-5/8	Round	5
5/64	33-0564	1	2	Round	10	11/32	33-1132	3-7/16	4-3/4	HEX	5
3/32	33-0332	1-1/4	2-1/4	Round	10	11/32	33-1132R	3-7/16	4-3/4	Round	5
7/64	33-0764	1-1/2	2-5/8	Round	10	23/64	33-2364	3-1/2	4-7/8	HEX	5
1/8	33-0018	1-5/8	2-3/4	Round	10	23/64	33-2364R	3-1/2	4-7/8	Round	5
9/64	33-0964	1-3/4	2-7/8	Round	10	3/8	33-0038	3-5/8	5	HEX	5
5/32	33-0532	2	3-1/8	Round	10	3/8	33-0038R	3-5/8	5	Round	5
11/64	33-1164	2-1/8	3-1/4	Round	10	25/64	33-2564	3-3/4	5-1/8	HEX	5
3/16	33-0316	2-5/16	3-1/2	HEX	10	25/64	33-2564R	3-3/4	5-1/8	Round	5
3/16	33-0316R	2-5/16	3-1/2	Round	10	13/32	33-1332	3-7/8	5-1/4	HEX	5
13/64	33-1364	2-7/16	3-5/8	HEX	10	13/32	33-1332R	3-7/8	5-1/4	Round	5
13/64	33-1364R	2-7/16	3-5/8	Round	10	27/64	33-2764	3-15/16	5-3/8	HEX	5
7/32	33-0732	2-1/2	3-3/4	HEX	10	27/64	33-2764R	3-15/16	5-3/8	Round	5
7/32	33-0732R	2-1/2	3-3/4	Round	10	7/16	33-0716	4-1/16	5-1/2	HEX	5
15/64	33-1564	2-5/8	3-3/7	HEX	10	7/16	33-0716R	4-1/16	5-1/2	Round	5
15/64	33-1564R	2-5/8	3-3/7	Round	10	29/64	33-2964	4-3/16	5-5/8	HEX	5
1/4	33-0014	2-3/4	4	HEX	10	29/64	33-2964R	4-3/16	5-5/8	Round	5
1/4	33-0014R	2-3/4	4	Round	10	15/32	33-1532	4-5/16	5-3/4	HEX	5
17/64	33-1764	2-7/8	4-1/8	HEX	10	15/32	33-1532R	4-5/16	5-3/4	Round	5
17/64	33-1764R	2-7/8	4-1/8	Round	10	31/64	33-3164	4-3/8	5-7/8	HEX	5
9/32	33-0932	2-15/16	4-1/4	HEX	10	31/64	33-3164R	4-3/8	5-7/8	Round	5
9/32	33-0932R	2-15/16	4-1/4	Round	10	1/2	33-0012	4-1/2	6	HEX	5
19/64	33-1964	3-1/16	4-3/8	HEX	5	1/2	33-0012R	4-1/2	6	Round	5
19/64	33-1964R	3-1/16	4-3/8	Round	5	F	33-000F			HEX	10
5/16	33-0516	3-3/16	4-1/2	HEX	5	U	33-000U			HEX	5
5/16	33-0516R	3-3/16	4-1/2	Round	5						



Description: TWIST & LOCK DRILLS by AMETA have been specially designed to offer incomparable strength and increased flexibility, thus expanding their life span by up to 65%.

- Made of high speed steel grade HSS/C05 and Cobalt M35 surpassing the M2 standard
- Self-centering *SPLIT POINT*
- Excellent resistance to shock with greater flexibility
- The 6 face shank "HEX SYSTEM" prevents slipping and provides tight chuck grip
- High performance on stainless steel

FRACTIONAL DRILLBITS KITS SERIES-33

Total of Bits	code	Dimension	Kit type	Bits type
29	33-0001	1/16" to 1/2" by 64"	Steel	Cobalt
29	33-0001P	1/16" to 1/2" by 64"	Plastic	Cobalt
29	33-0001R	1/16" to 1/2" by 64"	Steel	Cobalt Round
21	33-0004	1/16" to 3/8" by 64"	Steel	Cobalt
15	33-0002	1/16" to 1/2" by 32"	Steel	Cobalt
13	33-0003	1/16" to 1/4" by 64"	Steel	Cobalt
365	33-000D	1/16" to 1/2" by 64"	Steel	Cobalt
189	33-000Dsmall	1/16" to 1/2" by 64"	Steel	Cobalt





▶ HSS/CO5 METRIC SIZES

SERIES 38

Diameter	code	Lenght spiral	Total lenght	Shaft	
1 mm	38-0001	17	41	Round	10
1.5 mm	38-0015	22	48	Round	10
2 mm	38-0002	25	51	Round	10
2.5 mm	38-0025	35	60	Round	10
3 mm	38-0003	41	70	Round	10
3.3 mm	38-0033	44	73	Round	10
3.5 mm	38-0035	44	73	Round	10
4 mm	38-0004	54	83	Round	10
4.2 mm	38-0042	54	83	Round	10
4.5 mm	38-0045	56	86	Round	10
5 mm	38-0005	62	92	HEX	10
5.5 mm	38-0055	64	95	HEX	10
6 mm	38-0006	70	102	HEX	10
6.5 mm	38-0065	73	105	HEX	10
6.7 mm	38-0067	73	105	HEX	10
7 mm	38-0007	73	105	HEX	10
7.5 mm	38-0075	78	111	HEX	10
8 mm	38-0008	81	114	HEX	10
8.5 mm	38-0085	87	121	HEX	10
9 mm	38-0009	89	124	HEX	10
9.5 mm	38-0095	92	127	HEX	10
10 mm	38-0010	95	130	HEX	10
10.2 mm	38-0102	95	130	HEX	10
10.5 mm	38-0105	98	133	HEX	10
11 mm	38-0011	103	140	HEX	5
11.5 mm	38-0115	106	143	HEX	5
12 mm	38-0012	111	149	HEX	5
12.5 mm	38-0125	114	152	HEX	5
13 mm	38-0013	114	152	HEX	5



SET of 25 metric drill bits

25-piece drill bit set 1mm to 13mm



Order No. 38-1000

Description: TWIST & LOCK DRILLS by AMETA have been specially designed to offer incomparable strength and increased flexibility, thus expanding their life span by up to 65%.

- Made of high speed steel grade HSS/CO5 and Cobalt M35 surpassing the M2 standard
- Self-centering *SPLIT POINT*
- Excellent resistance to shock with greater flexibility
- The 6 face shank "HEX SYSTEM" prevents slipping and provides tight chuck grip
- High performance on stainless steel

▶ HSS/CO5 WIRE GAGE SIZES

SERIES 31

Diameter	code	Lenght spiral	Total lenght	Shaft		Diameter	code	Lenght spiral	Total lenght	Shaft	
#1	31-0001	2-5/8	3-7/8	HEX	10	#33	31-0033	1-1/2	2-5/8	Round	10
#2	31-0002	2-5/8	3-7/8	HEX	10	#34	31-0034	1-1/2	2-5/8	Round	10
#3	31-0003	2-1/2	3-3/4	HEX	10	#35	31-0035	1-1/2	2-5/8	Round	10
#4	31-0004	2-1/2	3-3/4	HEX	10	#36	31-0036	1-7/16	2-1/2	Round	10
#5	31-0005	2-1/2	3-3/4	HEX	10	#37	31-0037	1-7/16	2-1/2	Round	10
#6	31-0006	2-1/2	3-3/4	HEX	10	#38	31-0038	1-7/16	2-1/2	Round	10
#7	31-0007	2-7/16	3-5/8	HEX	10	#39	31-0039	1-3/8	2-3/8	Round	10
#8	31-0008	2-7/16	3-5/8	HEX	10	#40	31-0040	1-3/8	2-3/8	Round	10
#9	31-0009	2-7/16	3-5/8	HEX	10	#41	31-0041	1-3/8	2-3/8	Round	10
#10	31-0010	2-7/16	3-5/8	HEX	10	#42	31-0042	1-1/4	2-1/4	Round	10
#11	31-0011	2-5/16	3-1/2	HEX	10	#43	31-0043	1-1/4	2-1/4	Round	10
#12	31-0012	2-5/16	3-1/2	HEX	10	#44	31-0044	1-1/8	2-1/8	Round	10
#13	31-0013	2-5/16	3-1/2	HEX	10	#45	31-0045	1-1/8	2-1/8	Round	10
#14	31-0014	2-3/16	3 3/8	Round	10	#46	31-0046	1-1/8	2-1/8	Round	10
#15	31-0015	2-3/16	3-3/8	Round	10	#47	31-0047	1	2	Round	10
#16	31-0016	2-3/16	3-3/8	Round	10	#48	31-0048	1	2	Round	10
#17	31-0017	2-3/16	3-3/8	Round	10	#49	31-0049	1	2	Round	10
#18	31-0018	2-1/8	3-1/4	Round	10	#50	31-0050	1	2	Round	10
#19	31-0019	2-1/8	3-1/4	Round	10	#51	31-0051	1	2	Round	10
#20	31-0020	2-1/8	3-1/4	Round	10	#52	31-0052	7/8	1-7/8	Round	10
#21	31-0021	2-1/8	3-1/4	Round	10	#53	31-0053	7/8	1-7/8	Round	10
#22	31-0022	2	3-1/8	Round	10	#54	31-0054	7/8	1-7/8	Round	10
#23	31-0023	2	3-1/8	Round	10	#55	31-0055	7/8	1-7/8	Round	10
#24	31-0024	2	3-1/8	Round	10	#56	31-0056	3/4	1-3/4	Round	10
#25	31-0025	1-7/8	3	Round	10	#57	31-0057	3/4	1-3/4	Round	10
#26	31-0026	1-7/8	3	Round	10	#58	31-0058	11/16	1-5/8	Round	10
#27	31-0027	1-7/8	3	Round	10	#59	31-0059	11/16	1-5/8	Round	10
#28	31-0028	1-3/4	2-7/8	Round	10	#60	31-0060	11/16	1-5/8	Round	10
#29	31-0029	1-3/4	2-7/8	Round	10						
#30	31-0030	1-3/4	2-3/4	Round	10						
#31	31-0031	1-5/8	2-3/4	Round	10						
#32	31-0032	1-5/8	2-3/4	Round	10						

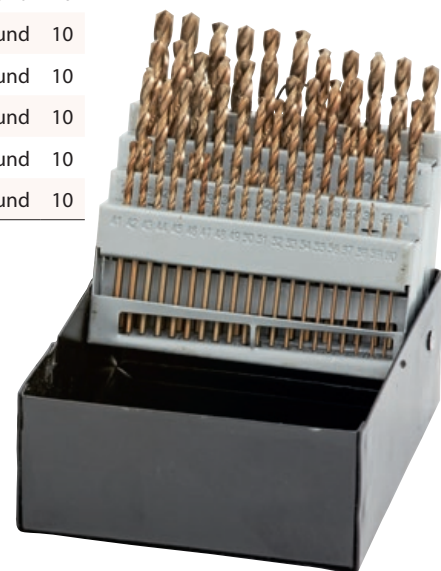

Description: TWIST & LOCK DRILLS by AMETA have been specially designed to offer incomparable strength and increased flexibility, thus expanding their life span by up to 65%.

- Made of high speed steel grade HSS/CO5 and Cobalt M35 surpassing the M2 standard
- Self-centering *SPLIT POINT*
- Excellent resistance to shock with greater flexibility
- The 6 face shank "HEX SYSTEM" prevents slipping and provides tight chuck grip
- High performance on stainless steel

SET of 60 wire gage size drill bits

60-piece drill bit set #1 to #60

Order No. 31-1001



▶ HSS/CO5 FRACTIONNAL STUBBY

SERIES 34

Diameter	code	Lenght spiral	Total lenght	Shaft		Diameter	code	Lenght spiral	Total lenght	Shaft	
1/16	34-0116				10	15/64	34-1564			Round	10
5/64	34-0564				10	1/4	34-0014			Round	10
3/32	34-0332				10	17/64	34-1764			Round	10
7/64	34-0764				10	9/32	34-0932			Round	10
1/8	34-0018				10	19/64	34-1964			Round	10
9/64	34-0964				10	5/16	34-0516			Round	5
5/32	34-0532				10	21/64	34-2164			Round	5
11/64	34-1164				10	11/32	34-1132			Round	5
3/16	34-0316				10	23/64	34-2364			Round	5
13/64	34-1364				10	3/8	34-0038			HEX	5
7/32	34-0732				10						



▶ HSS/CO5 WIRE GAGE SIZES STUBBY

SERIES 37

Diameter	code	Lenght spiral	Total lenght	Shaft		Diameter	code	Lenght spiral	Total lenght	Shaft	
#1	37-0001			HEX	10	#21	37-0021			Round	10
#2	37-0002			HEX	10	#22	37-0022			Round	10
#3	37-0003			HEX	10	#23	37-0023			Round	10
#4	37-0004			HEX	10	#24	37-0024			Round	10
#5	37-0005			HEX	10	#25	37-0025			Round	10
#6	37-0006			HEX	10	#26	37-0026			Round	10
#7	37-0007			HEX	10	#27	37-0027			Round	10
#8	37-0008			HEX	10	#28	37-0028			Round	10
#9	37-0009			HEX	10	#29	37-0029			Round	10
#10	37-0010			HEX	10	#30	37-0030			Round	10
#11	37-0011			HEX	10	#31	37-0031			Round	10
#12	37-0012			HEX	10	#32	37-0032			Round	10
#13	37-0013			HEX	10	#33	37-0033			Round	10
#14	37-0014			Round	10	#34	37-0034			Round	10
#15	37-0015			Round	10	#35	37-0035			Round	10
#16	37-0016			Round	10	#36	37-0036			Round	10
#17	37-0017			Round	10	#37	37-0037			Round	10
#18	37-0018			Round	10	#38	37-0038			Round	10
#19	37-0019			Round	10	#39	37-0039			Round	10
#20	37-0020			Round	10	#40	37-0040			Round	10

Description: TWIST & LOCK DRILLS by AMETA have been specially designed to offer incomparable strength and increased flexibility, thus expanding their life span by up to 65%.

- Made of high speed steel grade HSS/CO5 and Cobalt M35 surpassing the M2 standard
- Self-centering *SPLIT POINT*
- Excellent resistance to shock with greater flexibility

▶ HSS/CO5 DOUBLE-END

SERIES 30

Dimension	code	Type	Lenght spiral	Total lenght	
1/8	30-0018	DOUBLE-END	1/2	2	10
3/16	30-0316	DOUBLE-END	1/2	2	10



▶ HSS/CO5 EXTRA STUBBY

SERIES 39

Dimension	code	Type	Lenght spiral	Total lenght	
1/4	39-0014	EXTRA STUBBY 1/4 shaft			1
5/16	39-0516	EXTRA STUBBY 1/4 shaft			1



▶ MASTER DRILLBITS DISPLAY

SERIES 33

TWIST & LOCK DRILLS by AMETA have been specially designed to offer incomparable strength and increased flexibility, thus expanding their life span by up to 65%.

- Made of high speed steel grade HSS/CO5 and Cobalt M35 surpassing the M2 standard
- Self-centering *SPLIT POINT*
- Excellent resistance to shock with greater flexibility
- The 6 face shank "HEX SYSTEM" prevents slipping and provides tight chuck grip
- High performance on stainless steel • Haute performance sur l'SST

385 DRILL BITS OF 33- SERIES (M35 COBALT, HSS/CO5):

20 drill bits of diameter:
1/16", 5/64", 3/32", 7/64", 1/8", 9/64", 5/32", 11/64", 3/16", 13/64", 7/32", 15/64", 1/4"

10 drill bits of diameter:
17/64", 9/32", 19/64", 5/16", 21/64", 11/32", 23/64", 3/8", 25/64"

5 drill bits of diameter:
13/32", 27/64", 7/16", 29/64", 15/32", 31/64", 1/2"

Order No. 33-000D

189 DRILL BITS OF 33- SERIES (M35 COBALT, HSS/CO5):

10 drill bits of diameter:
1/16", 5/64", 3/32", 7/64", 1/8", 9/64", 5/32", 11/64", 3/16", 13/64", 7/32", 15/64", 1/4"

5 drill bits of diameter:
17/64", 9/32", 19/64", 5/16", 21/64", 11/32", 23/64", 3/8", 25/64"



2 drill bits of diameter:
13/32", 27/64", 7/16", 29/64", 15/32", 31/64", 1/2"

Order No. 33-000D-small



▶ HSS/CO5 FRACTIONNAL 33/64" to 1 1/2"

SERIES 35

Diameter	code	Lenght spiral	Total lenght	Shaft		Diameter	code	Lenght spiral	Total lenght	Shaft	
33/64	35-3364	3	6	HEX	1	25/32	35-2532	3	6	HEX	1
17/32	35-1732	3	6	HEX	1	13/16	35-1316	3	6	HEX	1
35/64	35-3564	3	6	HEX	1	27/32	35-2732	3	6	HEX	1
9/16	35-0916	3	6	HEX	1	7/8	35-0708	3	6	HEX	1
37/64	35-3764	3	6	HEX	1	29/32	35-2932	3	6	HEX	1
19/32	35-1932	3	6	HEX	1	15/16	35-1516	3	6	HEX	1
39/64	35-3964	3	6	HEX	1	31/32	35-3132	3	6	HEX	1
5/8	35-0508	3	6	HEX	1	1	35-0001	3	6	HEX	1
41/64	35-4164	3	6	HEX	1	1 1/16	35-0116	3	6	HEX	1
21/32	35-2132	3	6	HEX	1	1 1/8	35-0118	3	6	HEX	1
43/64	35-4364	3	6	HEX	1	1 3/16	35-0316	3	6	HEX	1
11/16	35-1116	3	6	HEX	1	1 1/4	35-0114	3	6	HEX	1
45/64	35-4564	3	6	HEX	1	1 5/16	35-0516	3	6	HEX	1
23/32	35-2332	3	6	HEX	1	1 3/8	35-1308	3	6	HEX	1
47/64	35-4764	3	6	HEX	1	1 7/16	35-1716	3	6	HEX	1
3/4	35-0304	3	6	HEX	1	1 1/2	35-0112	3	6	HEX	1



SET of 1/2" hexagonal shank bits

8-piece drill bit set:

9/16" - 13/16" - 5/8" - 7/8" - 11/16" - 15/16" - 3/4" - 1"

Order No. 35-0002



SET of 3/8" hexagonal shank bits



29-piece drill bit set 3/8" shank 1/16" to 1/2" by 64"

Order No. 36-0001

Order No. 36-0001P (high density plastic)

▶ HSS/CO5 FRACTIONNAL 25/64" to 1/2"



SERIES 36 SHAFT 3/8"

Diameter	code	Lenght spiral	Total lenght	Shaft		Diameter	code	Lenght spiral	Total lenght	Shaft	
25/64	36-2564	3-3/4	5-1/8	HEX	10	29/64	36-2964	4-3/16	5-5/8	HEX	5
13/32	36-1332	3-7/8	5-1/4	HEX	10	15/32	36-1532	4-5/16	5-3/4	HEX	5
27/64	36-2764	3-15/16	5-3/8	HEX	5	31/64	36-3164	4-3/8	5-7/8	HEX	5
7/16	36-0716	4-1/16	5-1/2	HEX	5	1/2	36-0012	4-1/2	6	HEX	5



DRILLBITS BLACK & GOLD FRACTIONNAL

SERIE 40 / OXYDE BRONZE DRILLBITS 3-FLAT

Diame-	code	Lenght spiral	Total lenght	Shaft		Diame-	code	Lenght spiral	Total lenght	Shaft	
1/16	40-0116	7/8	1-7/8	Round	10	19/64	40-1964	3-1/16	4-3/8	3-flat	5
5/64	40-0564	1	2	Round	10	5/16	40-0516	3-3/16	4-1/2	3-flat	5
3/32	40-0332	1-1/4	2-1/4	Round	10	21/64	40-2164	3-5/16	4-5/8	3-flat	5
7/64	40-0764	1-1/2	2-5/8	Round	10	11/32	40-1132	3-7/16	4-3/4	3-flat	5
1/8	40-0018	1-5/8	2-3/4	Round	10	23/64	40-2364	3-1/2	4-7/8	3-flat	5
9/64	40-0964	1-3/4	2-7/8	Round	10	3/8	40-0038	3-5/8	5	3-flat	5
5/32	40-0532	2	3-1/8	Round	10	25/64	40-2564	3-3/4	5-1/8	3-flat	5
11/64	40-1164	2-1/8	3-1/4	Round	10	13/32	40-1332	3-7/8	5-1/4	3-flat	5
3/16	40-0316	2-5/16	3-1/2	3-flat	10	27/64	40-2764	3-15/16	5-3/8	3-flat	5
13/64	40-1364	2-7/16	3-5/8	3-flat	10	7/16	40-0716	4-1/16	5-1/2	3-flat	5
7/32	40-0732	2-1/2	3-3/4	3-flat	10	29/64	40-2964	4-3/16	5-5/8	3-flat	5
15/64	40-1564	2-5/8	3-3/7	3-flat	10	15/32	40-1532	4-5/16	5-3/4	3-flat	5
1/4	40-0014	2-3/4	4	3-flat	10	31/64	40-3164	4-3/8	5-7/8	3-flat	5
17/64	40-1764	2-7/8	4-1/8	3-flat	10	1/2	40-0012	4-1/2	6	3-flat	5
9/32	40-0932	2-15/16	4-1/4	3-flat	10						

Description: The new AMETA BLACK & GOLD bits have been specially designed to offer incomparable drilling hardness as well as increased flexibility, allowing greater durability.

- 135°, Split Point, AINSI B94-11M
- Bronze oxide coating for additionnal tempering and stress relief
- 3 flat shank for a better grip in chuck



DRILLBITS KITS B&G SERIES-40

Total of Bits	code	Dimension	Kit type	Bits type
29	40-0001	1/16" to 1/2" by 64"	Steel	Black&Gold
29	40-0001P	1/16" to 1/2" by 64"	Plastique	Black&Gold
21	40-0004	1/16" to 3/8" by 64"	Steel	Black&Gold
15	40-0002	1/16" to 1/2" by 32"	Steel	Black&Gold
13	40-0003	1/16" to 1/4" by 64"	Steel	Black&Gold
365	40-000D	1/16" to 1/2" by 64"	Steel	Black&Gold
189	40-000Dsmall	1/16" to 1/2" by 64"	Steel	Black&Gold





▶ TITANIUM COATED HIGH SPEED STEP DRILL

HEXAGONAL 3/8" & 1/4" SHANK



Forme	code	Irwin* No	Dimension	Gradation	Hole number	Lenght	Shaft HEX
A	30-0031	10231	1/8-1/2	1/32	13	76mm	1/4
B	30-0032	10232	3/16-1/2	1/16	6	90mm	1/4
C	30-0033	10233	1/4-3/4	1/16	9	68mm	1/4
D	30-0034	10234	3/16-7/8	1/16	12	78mm	1/4
E	30-0010	10310	1/2	-	1	50mm	1/4
F	30-0011	10311	7/8	-	1	54mm	1/4
G	30-0012	10312	3/8	-	1	50mm	1/4
H	30-0013	10313	1-1/8	-	1	65mm	3/8
I	30-0020	10220	9/16-1	1/16	8	70mm	1/4
L	30-0021	10221	13/16-1 3/8	1/16	10	80mm	3/8

*Irwin = Marque de commerce déposée

Description: Step drill bits are the best tools to drill or to widen holes in sheet metal, stiff plastic or composite materials up to 1/8" thickness • Each Ameta step drill bit provides special TITANIUM coating to offer superior performance and life against the conventional drill bits.

- The 135° split point self-center avoids the need of center punching
- 6 face shank design for tight keyless chuck grip
- High performance and precision drilling on stainless steel, metal and aluminum • Idéal pour percer SST, Steel standard et Aluminum

SET of 3 step drill bits

3-piece set of top sellers:
30-0031 - 30-0032 - 30-0033

Order No. 30-0001



COBALT M35 COUNTERSINK BITS

UNITS & SET

Forme	Diameter	code	Angle	Total length	Shaft	Type	
A	1/4"	39-1400	82°	2"	1/4"	Cobalt M35	1
B	3/8"	39-0038	82°	2"	1/4"	Cobalt M35	1
C	1/2"	39-0012	82°	2"	1/4"	Cobalt M35	1
D	5/8"	39-0058	82°	2 1/4"	1/4"	Cobalt M35	1
E	3/4"	39-0034	82°	2 3/4"	1/4"	Cobalt M35	1



COUNTERSINK BITS KIT:
Order No. 39-0001

Description: Made from M35 steel, thus repelling the established standards of M2Al steel. Our tapered drills will meet your highest requirements. In addition, our specially developed Cobalt Grade 5 Co5 treatment significantly reduces the heat generated by friction. An angle of 82° ensures uniform milling and chamfering on stainless steel, mild steel and aluminum.





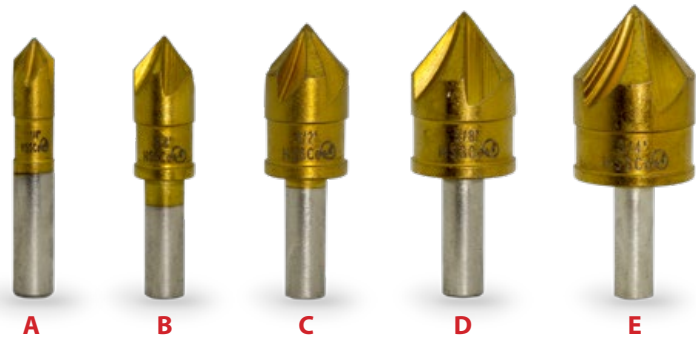

ROTATION SPEED (RPM)

Diameter	code	Alu.	COPPER	Steel	SST	NO METAL
1/4"	39-1400	1505	1404	752	602	1755
3/8"	39-0038	1004	937	502	401	1171
1/2"	39-0012	752	702	376	301	878
5/8"	39-0058	602	562	301	241	702
3/4"	39-0034	1502	468	251	201	585



ANNULAR CUTTER SPEEDS FOR BEST PERFORMANCE

ANNULAR CUTTER SPEED GUIDE

Metric dimension mm	12-18	19-25	26-32	33-39	40-46	47-53	54-60	61-70	71-80	81-90	91-100	101-112	113-124	125-136	137-150
inches dimension Fractional	7/16 11/16	3/4 1	1-1/16 1-1/4	1-5/16 1-9/16	1-5/8 1-13/16	1-7/8 2-1/16	2-1/8 2-3/8	2-13/32 2-3/4	2-51/64 3-5/32	3-3/16 3-9/16	3-19/32 3-15/16	3-31/32 4-13/32	4-15/32 4-7/8	4-15/16 5-11/32	5-13/32 5-29/32
 Steel < 500 N	660 440	420 320	305 250	240 200	195 170	165 150	145 130	125 15	110 100	95 90	85 80	75 70	68 65	63 58	57 50
 Steel < 750 N	530 350	340 250	245 200	195 165	160 140	135 120	115 105	163 90	87 78	77 70	68 63	62 56	55 51	50 46	45 42
 Steel < 900 N	340 265	250 190	185 150	145 125	120 105	100 90	88 80	78 68	67 59	58 53	52 48	47 42	41 39	38 35	34 31
 Steel < 1100 N	265 175	165 130	125 100	95 80	79 70	67 60	58 53	52 45	44 40	39 35	34 32	31 28	27 26	25 23	22 21
 Aluminum < 10% Si	320 210	200 150	145 120	115 95	90 85	80 72	70 63	62 54	53 47	46 42	41 38	37 33	32 30	29 28	27 25
 Aluminum > 10% Si	980 655	620 470	455 370	360 305	295 255	250 225	220 195	193 170	165 150	145 130	129 117	116 105	104 95	94 86	85 78
 SST	480 320	300 230	200 180	175 147	143 125	122 108	106 95	93 81	80 71	70 63	62 57	56 51	50 46	45 42	41 38

▶ HIGH SPEED HSS ANNULAR FRACTIONAL

FRAISES ANNULAIRE SHAFT WELDON HAUTE QUALITÉE



Fractionnal sizes	Metric sizes	item # annular 1"	item # annular 2"	
7/16"	11.1mm	24-0716	25-0716	1
1/2"	12.7mm	24-0012	25-0012	1
9/16"	14.3mm	24-0916	25-0916	1
5/8"	15.9mm	24-0058	25-0058	1
11/16"	17.5mm	24-1116	25-1116	1
3/4"	19.0mm	24-0034	25-0034	1
13/16"	20.6mm	24-1316	25-1316	1
7/8"	22.2mm	24-0078	25-0078	1
15/16"	23.8mm	24-1516	25-1516	1
1"	25.4mm	24-10001	25-10001	1
1-1/16"	27.0mm	24-10116	25-10116	1
1-1/8"	28.6mm	24-10018	25-10018	1
1-3/16"	30.2mm	24-10316	25-10316	1
1-1/4"	31.8mm	24-10014	25-10014	1
1-5/16"	33.3mm	24-10516	25-10516	1
1-3/8"	34.9mm	24-10038	25-10038	1
1-7/16"	36.5mm	24-10716	25-10716	1
1-1/2"	38.1mm	24-10012	25-10012	1
1-9/16"	39.7mm	24-10916	25-10916	1
1-5/8"	41.3mm	24-10058	25-10058	1
1-11/16"	42.8mm	24-11116	25-11116	1
1-3/4"	44.5mm	24-10034	25-10034	1
1-13/16"	46.0mm	24-11316	25-11316	1
1-7/8"	47.6mm	24-10078	25-10078	1
1-15/16"	49.2mm	24-11516	25-11516	1
2"	50.8mm	24-20002	25-20002	1

▶ PILOT PINS & ADAPTOR

ACCESSORIES FOR ANNULAR CUTTERS

Ref.	Description	Annular Cutter Type	Notes		Art.-No
A	Pilot Pin 3"	for # 24-0716	for # 24-0716 only	1	28-0001
B	Pilot Pin 3"	for Series 24 & 26	for 1 inch / 25 mm depth only	1	28-0002
C	Pilot Pin 4"	for Series 25 & 27	for 2 inch / 50 mm depth only	1	28-0003



HIGH SPEED HSS ANNULAR METRIC SIZES









ANNULAR CUTTERS BY UNIT

Dimension	item # annular 25mm	item # annular 50mm	
12mm	26-0012		1
13mm	26-0013	27-0013	1
14mm	26-0014	27-0014	1
16mm	26-0016	27-0016	1
17mm	26-0017	27-0017	1
18mm	26-0018		1
19mm	26-0019	27-0019	1
20mm	26-0020		1
21mm	26-0021	27-0021	1
22mm	26-0022	27-0022	1
24mm	26-0024	27-0024	1
25mm	26-0025	27-0025	1
26mm	26-0026		1
27mm	26-0027	27-0027	1
29mm	26-0029	27-0029	1
30mm	26-0030	27-0030	1
32mm	26-0032	27-0032	1
33mm	26-0033	27-0033	1
35mm	26-0035	27-0035	1
37mm	26-0037	27-0037	1
38mm	26-0038	27-0038	1
40mm	26-0040	27-0040	1
41mm	26-0041	27-0041	1
43mm	26-0043	27-0043	1
44mm	26-0044	27-0044	1
46mm	26-0046	27-0046	1
48mm	26-0048	27-0048	1
49mm	26-0049	27-0049	1
51mm	26-0051	27-0051	1



Description:

- Special steel for extreme hardness up to 69 HRC
- Universal shank fitting most core drilling machines
- Better flexibility due to the step hardening process
- Advanced flute design

Material	Type	••• Optimal •• Good • Possible
	Steel < 500 N	•••
	Steel< 750 N	•••
	Steel< 900 N	••
	Steel< 1100 N	•
	Aluminum < 10% Si	••
	Aluminum > 10% Si	•
	Cast	••
	SST	••

DOUBLE CUT CARBIDE BURRS

CARBIDE BURRS BY UNIT

A selection of high quality carbide burrs for heavy duty and professional applications. The high quality finishing guarantees maximum performance in any working conditions and cutting sharpness throughout the time.



CYLINDRICAL ISO-A – DIN ZYA

(Steel/Steel – inox /Aluminum)

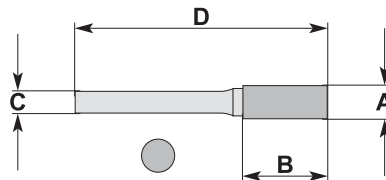

Art.-No.	A	B	C	D
88-1001	1/4	5/8	1/4	2 1/4
88-1002	3/8	3/4	1/4	2 1/2
88-1003 <i>Alu</i>	3/8	3/4	1/4	2 1/2
88-1004	1/2	1	1/4	2 3/4
88-1006	21/64	3/4	1/4	2 17/32
88-1008	29/64	1	1/4	2 25/32
88-1010	5/8	1	1/4	2 7/8
88-1012 <i>Alu</i>	1/2	1	1/4	2 3/4

CYLINDRICAL ISO-B – DIN ZYA (S)

(Steell/inox)

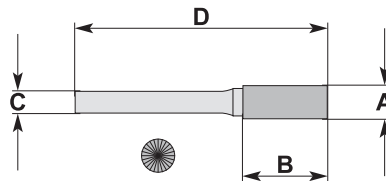

Art.-No.	A	B	C	D
88-2001	1/4	5/8	1/4	2 1/4
88-2002	3/8	3/4	1/4	2 1/2
88-2003	1/2	1	1/4	2 3/4

CYLINDRICAL ROUND ISO-C – DIN WRC

(Steel/Steel – inox /Aluminum)

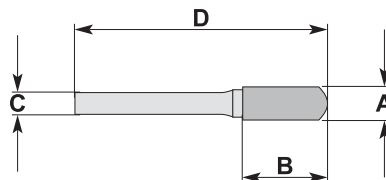

Art.-No.	A	B	C	D
88-3001	1/4	5/8	1/4	2 1/4
88-3002	3/8	3/4	1/4	2 1/2
88-3003	1/2	1	1/4	2 3/4
88-3004 <i>Alu</i>	1/2	1	1/4	2 3/4

POINTED CONE ISO-M – DIN SKM

(Steel/inox)

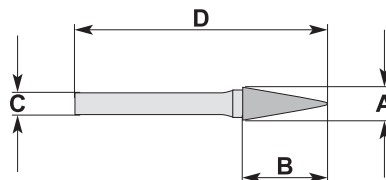

Art.-No.	A	B	C	D
88-4001	1/2	1	1/4	2 3/4

BALL ISO-D – DIN KUD

(Steel/inox)

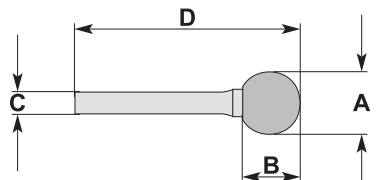

Art.-No.	A	B	C	D
88-5000	1/4	7/32	1/4	2
88-5001	3/8	5/16	1/4	2
88-5002	1/2	7/16	1/4	2

TAPER RADIUS ISO-L – DIN KEL

(Steel/Steel – inox /Aluminum)

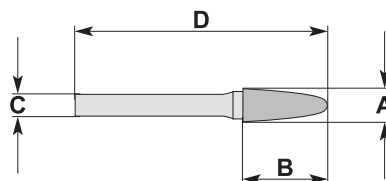

Art.-No.	A	B	C	D
88-6001	1/2	1	1/4	2 3/4
88-6002 <i>Alu</i>	1/2	1	1/4	2 3/4

**TREE POINTED END
ISO-G – DIN SPG**

(Steel/Steel – SST /Aluminum)

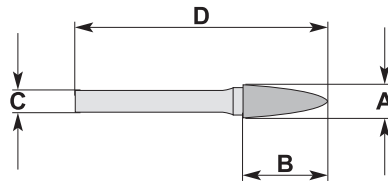

Art.-No.	A	B	C	D
88-7001	1/4	5/8	1/4	2
88-7002	3/8	3/4	1/4	2 3/4
88-7003	1/2	1	1/4	2 3/4
88-7004 Alu	1/2	1	1/4	2 3/4

**OVAL
ISO-E – DIN TRE**

(Steel/inox)

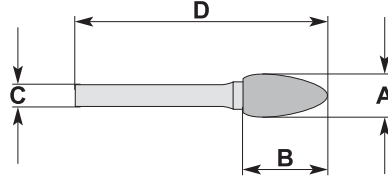

Art.-No.	A	B	C	D
88-8001	1/2	7/8	1/4	2 1/2

**TREE RADIUS
ISO-F – DIN RBF**

(Steel/Steel –SST/Aluminum)

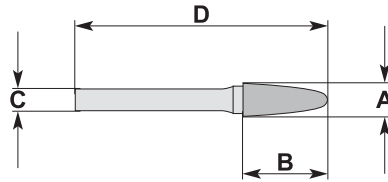

Art.-No.	A	B	C	D
88-9001	3/8	3/4	1/4	2 3/4
88-9002	1/2	1	1/4	2 3/4
88-9003 Alu	1/2	1	1/4	2 3/4

**CYLINDRICAL
ISO-A – DIN ZYA 6"**

(Steel/Steel – SST /Aluminum)

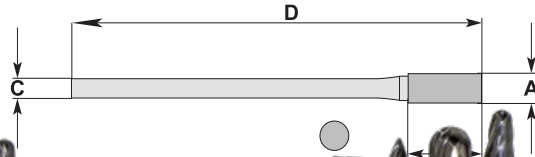

Art.-No.	A	B	C	D
88-1605	1/4	5/8	1/4	6 1/2
88-1607	3/8	3/4	1/4	6 21/32
88-1609	1/2	1	1/4	7



CARBIDE BURRS SET

4 units STEEL:

88-1002, 88-3002, 88-2001, 88-6001

Item number: 88-0001

CARBIDE BURRS SET

4 units STEEL: **Aluminum**

88-1003, 88-3004, 88-6002, 88-7004

Item number: 88-0002

Products Display P044

for shaft 1/4 items

Width: 495 mm [19 1/2 in.]

Height: 165 mm [6 1/2 in.]

Length: 165 mm [6 1/2 in.]

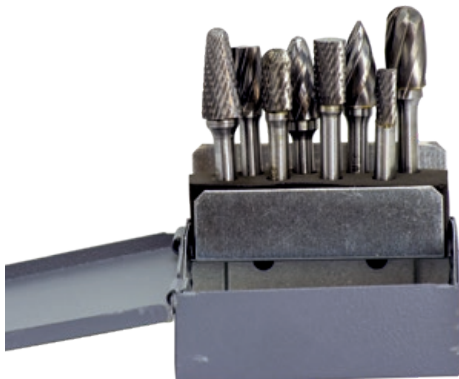

CARBIDE BURRS SET

8 units STEEL/ALU:

88-1002, 88-3002, 88-2001, 88-6001, 88-1003, 88-3004, 88-6002 et 88-7004

Item number: 88-0003

CARBIDE BURRS SET

8 units STEEL:

88-1001, 88-1002, 88-1004, 88-2002, 88-3002, 88-3003, 88-6001, 88-7002





Item number: 88-0004



**SQUEEZE ACTION HEAVY DUTY LONG LIFE METAL TIP
WATER-RESISTANT Metal tip permanent marker with
oil based paint for all surfaces**

- Ultra-fine precision marking metal tip (1.4 mm).
- Quick-drying & heat-resistant up to +316°C [+600°F].
- Marking temperature range: -46°C up to +66°C [-50°F up to +150°F].
- Does not dry out even with cap not in place.
- Paint can be removed with 75-17 Metaflux Citrus without harming the surface.
- Our markers are chlorine free

▶ METAL TIP PERMANENT MARKERS

SUPER MET-AL PAINT MARKERS				
Color			Blister	Art.-No
	Pink	6	yes	M-1800
	Green	6	yes	M-1600
	Orange	6	yes	M-1700
	White	6	yes	M-3000
	Blue	6	yes	M-1500
	Black	6	yes	M-1323
	Yellow	6	yes	M-1324
	Red	6	yes	M-1326
	Yellow	6	yes	M-1900
	Gold	6	yes	M-3011
	White	6	yes	M-1295





▶ FIBER TIP PERMANENT MARKERS

SUPER MET-AL PAINT MARKERS				
Color			Blister	Art.-No
	Black	6	yes	M-4002
	Black	12	no	M-4002B
	Yellow	6	yes	M-4001
	Yellow	12	no	M-4001B
	Red	6	yes	M-4003
	Red	12	no	M-4003B
	White	6	yes	M-4000
	White	12	no	M-4000B
	Yellow GALVANISED STEEL	6	yes	M-4047
	White GALVANISED STEEL	6	yes	M-4046



▶ FIBER TIP MARKER HIGH TEMPERATURE

SUPER MET-AL HEAT RESISTANT				
Color			Blister	Art.-No
	Yellow	12	no	M-9000B
	White	12	no	M-9001B





Dimensions:

L = 19 cm x P = 23 cm x H = 32 cm.
[9.05 in. x 7.48 in. x 12.60 in.]



▶ SUPER MET-AL DISPLAY 24 UNITS





24 ASSORTED MARKERS ON DISPLAY

Color	code	description	
assorted	M-24DPI	24 Metal Tip Markers	1
assorted	M-24DPY	24 Fiber Tip Markers	1

Description: Elegant cardboard counter top display with 24 assorted color metal or fiber tip markers. Easy color identification through colored plastic marker caps reporting the same marking colors. The optimal dimensions make the counter top display very convenient and attractive.





▶ FIBER TIP WASHABLE MARKERS

SUPER MET-AL WATER BASED PAINT MARKERS

Color			Blister	Art.-No
	Blue	6	yes	M-5005
	White	6	yes	M-5000
	Yellow	6	yes	M-5001
	Red	6	yes	M-5003





▶ AUTO PART PAINT MARKER

SUPER MET-AL LARGE FIBER TIP

Color			Blister	Art.-No
	White	6	yes	08105
	Yellow	6	yes	08107
	Pink	6	yes	08108



▶ PUMP ACTION INK PERMANENT MARKER

SUPER MET-AL INK

Color			Blister	Art.-No
	Noir	6	yes	07700
	Red	6	yes	07702
	Yellow	6	yes	07704

▶ FINE LINE PAINT MARKER

SUPER MET-AL PAINT

Color			Blister	Art.-No
	White	6	yes	06070

CONVERSION TABLE

Diameter inches	Equivalence in decimal	Equivalence in Millimeter	Diameter inches	Equivalence in decimal	Equivalence in Millimeter	Diameter inches	Equivalence in decimal	Equivalence in Millimeter	
1/64	.0156	0.40	22	.1570	3.99	17/32	.5312	13.50	
1/32	.0313	.080	21	.1590	4.04	35/64	.5469	13.90	
60	.0400	1.02	20	.1610	4.09	9/16	.5625	14.29	
59	.0410	1.04	-	.1654	4.20	37/64	.5781	14.68	
58	.0420	1.07	19	.1660	4.22	19/32	.5938	15.08	
57	.0430	1.09	18	.1695	4.31	39/64	.6094	15.48	
56	.0465	1.18	11/64	.1719	4.37	5/8	.6250	15.88	
3/64	.0469	1.19	17	.1730	4.39	41/64	.6406	16.27	
55	.0520	1.32	16	.1770	4.50	21/32	.6562	16.67	
54	.0550	1.40	15	.1800	4.57	43/64	.6719	17.07	
53	.0595	1.51	14	.1820	4.62	11/16	.6875	17.46	
1/16	.0625	1.59	13	.1850	4.70	45/64	.7031	17.86	
52	.0635	1.61	3/16	.1875	4.76	23/32	.7188	18.26	
51	.06700	1.70	12	.1890	4.80	47/64	.7344	18.65	
50	.0700	1.78	11	.1910	4.85	3/4	.7500	19.05	
49	.0730	1.85	10	.1935	4.91	49/64	.7656	19.45	
48	.0760	1.93	9	.1960	4.98	25/32	.7812	19.84	
5/64	.0781	1.98	-	.1969	5.00	13/16	.8125	20.64	
47	.0785	1.99	8	.1990	5.05	27/32	.8438	21.43	
-	.0787	2.00	7	.2010	5.11	7/8	.8750	22.23	
46	.0810	2.06	13/64	.2031	5.16	57/64	.8906	22.62	
45	.0820	2.08	6	.2040	5.18	29/32	.9062	23.02	
44	.0860	2.18	5	.2055	5.22	59/64	.9219	23.42	
43	.0890	2.26	4	.2090	5.31	15/16	.9375	23.81	
42	.0935	2.37	3	.2130	5.41	61/64	.9531	24.21	
3/32	.0938	2.38	7/32	.2188	5.56	31/32	.9688	24.61	
41	.0960	2.44	2	.2210	5.61	63/64	.9844	25.00	
40	.0980	2.49	1	.2280	5.79	1	1.0000	25.40	
-	.0984	2.50	15/64	.2344	5.95	1 1/32	1.0312	26.19	
39	.0995	2.53	1/4	.2500	6.35	1 1/16	1.0625	26.98	
38	.1015	2.58	F	.2570	6.53	1 3/32	1.0938	27.78	
37	.1040	2.64	-	.2638	6.70	1 1/8	1.1250	28.58	
36	.1065	2.71	17/64	.2656	6.75	1 5/32	1.1562	29.37	
7/64	.1094	2.78	9/32	.2812	7.15	1 3/16	1.1875	30.16	
35	.1100	2.79	19/64	.2969	7.54	1 7/32	1.2188	30.95	
34	.1110	2.82	5/16	.3125	7.94	1 1/4	1.2500	31.75	
33	.1130	2.87	21/64	.3281	8.33	Recommended rotation speed for drillbits			
-	.1142	2.90	-	.3346	8.50	Diameter	Soft Steel	SST	Aluminum
32	.1160	2.95	11/32	.3438	8.73	1/16	4900	2450	6110
31	.1200	3.05	23/64	.3594	9.13	3/32	3250	1600	4070
1/8	.1250	3.18	U	.3680	9.35	1/8	2450	1200	3060
30	.1285	3.26	3/8	.3750	9.53	5/32	1950	950	2450
-	.1299	3.30	25/64	.3906	9.92	3/16	1630	800	2040
29	.1360	3.45	-	.4016	10.20	7/32	1400	700	1750
28	.1405	3.57	13/32	.4062	10.32	1/4	1220	600	1530
9/64	.1406	3.58	27/64	.4219	10.72	5/16	980	500	1220
27	.1440	3.66	7/16	.4375	11.11	3/8	820	400	1020
26	.1470	3.73	29/64	.4531	11.51	7/16	700	350	870
25	.1495	3.80	15/32	.4688	11.91	1/2	610	300	760
24	.1520	3.86	31/64	.4844	12.30	5/8	490	250	610
23	.1540	3.91	1/2	.5000	12.70	3/4	410	200	510
5/32	.1562	3.97	33/64	.5156	13.10	7/8	350	170	440
						1	305	150	380
						1 1/4	245	120	310

Item #	Page	Item #	Page	Item #	Page	Item #	Page	Item #	Page	Item #	Page	Item #	Page	Item #	Page	Item #	Page		
6070	56	25-1316	50	27-0049	51	31-0037	43	33-1764	40	35-0114	46	37-0016	44	39-0012	47	44-1332	47	61-3060	20
7700	56	25-1516	50	27-0051	51	31-0038	43	33-1964	40	35-0116	46	37-0017	44	39-0014	45	44-1364	47	61-3080	20
7702	56	25-2002	50	28-0001	49	31-0039	43	33-2164	40	35-0118	46	37-0018	44	39-0034	47	44-1532	47	61-3212	20
7704	56	26-0012	51	28-0002	49	31-0040	43	33-2364	40	35-0304	46	37-0019	44	39-0038	47	44-1564	47	61-3218	20
8105	56	26-0013	51	28-0003	49	31-0041	43	33-2564	40	35-0316	46	37-0020	44	39-0058	47	44-1764	47	61-3260	20
8107	56	26-0014	51	29-0001	49	31-0042	43	33-2764	40	35-0508	46	37-0021	44	39-0516	45	44-1964	47	61-3280	20
8108	56	26-0016	51	30-0001	48	31-0043	43	33-2964	40	35-0516	46	37-0022	44	39-1400	47	44-2164	47	62-0001	6
24-0012	50	26-0017	51	30-0010	48	31-0044	43	33-3164	40	35-0708	46	37-0023	44	40-0012	41	44-2364	47	62-0002	7
24-0034	50	26-0018	51	30-0011	48	31-0045	43	33-0001R	41	35-0916	46	37-0024	44	40-0014	41	44-2564	47	62-0005	6
24-0058	50	26-0019	51	30-0012	48	31-0046	43	33-0001RP	41	35-1116	46	37-0025	44	40-0018	41	44-2764	47	62-0006	6
24-0078	50	26-2020	51	30-0013	48	31-0047	43	33-002R	41	35-1308	46	37-0026	44	40-0038	41	44-2964	47	62-0010	6
24-0716	50	26-0021	51	30-0018	45	31-0048	43	33-003R	41	35-1316	46	37-0027	44	40-0116	41	40-3164	41	62-0010A	31
24-0916	50	26-0022	51	30-0020	48	31-0049	43	33-004R	41	35-1516	46	37-0028	44	40-0316	41	45-0003	34	62-0011	6
24-10001	50	26-0024	51	30-0021	48	31-0050	43	33-0038R	41	35-1716	46	37-0029	44	40-0332	41	45-0004	34	62-0020	7
24-10012	50	26-0025	51	30-0031	48	31-0051	43	33-0316R	41	35-1732	46	37-0030	44	40-0364	41	45-000K	35	62-0021	7
24-10014	50	26-0026	51	30-0032	48	31-0052	43	33-0516R	41	35-1932	46	37-0031	44	40-0516	41	45-0021	34	62-0025	7
24-10018	50	26-0027	51	30-0033	48	31-0053	43	33-0716R	41	35-2132	46	37-0032	44	40-0532	41	45-003R	34	62-0026	7
24-10034	50	26-0029	51	30-0034	48	31-0054	43	33-0732R	41	35-2332	46	37-0033	44	40-0564	41	45-004G	35	62-0030	29
24-10038	50	26-0030	51	30-0316	45	31-0055	43	33-0932R	41	35-2532	46	37-0034	44	40-0716	41	45-004M	35	62-0031	36
24-10058	50	26-0032	51	31-0001	43	31-0056	43	33-1132R	41	35-2732	46	37-0035	44	40-0732	41	45-004R	34	62-0040	29
24-10078	50	26-0033	51	31-0002	43	31-0057	43	33-1332R	41	35-2932	46	37-0036	44	40-0764	41	45-006G	35	62-0050	29
24-10116	50	26-0035	51	31-0003	43	31-0058	43	33-1364R	41	35-3132	46	37-0037	44	40-0932	41	45-006M	35	62-0060	8
24-10316	50	26-0037	51	31-0004	43	31-0059	43	33-1532R	41	35-3364	46	37-0038	44	40-0964	41	45-008G	35	62-0061	8
24-10516	50	26-0038	51	31-0005	43	31-0060	43	33-1564R	41	35-3564	46	37-0039	44	40-1132	41	45-008M	35	62-0070	9
24-10716	50	26-0040	51	31-0006	43	31-1001	43	33-1764R	41	35-3764	46	37-0040	44	40-1164	41	45-0202	34	62-0071	9
24-10916	50	26-0041	51	31-0007	43	33-0001	40	33-1964R	41	35-3964	46	38-0001	42	40-1332	41	45-1000	36	62-0102	21
24-11116	50	26-0043	51	31-0008	43	33-0001P	40	33-2164R	41	35-4164	46	38-0002	42	40-1364	41	45-2000	36	62-0140	21
24-1116	50	26-0044	51	31-0009	43	33-0002	40	33-2364R	41	35-4364	46	38-0003	42	40-1532	41	45-2121	34	62-0160	21
24-11316	50	26-0046	51	31-0010	43	33-0003	40	33-2564R	41	35-4564	46	38-0004	42	40-1564	41	45-3000	36	62-0180	21
24-11516	50	26-0048	51	31-0011	43	33-0004	40	33-2764R	41	35-4764	46	38-0005	42	40-1764	41	45-4000	36	62-0202	21
24-1316	50	26-0049	51	31-0012	43	33-000D	40	33-2964R	41	36-0001	46	38-0006	42	40-1964	41	45-4558	35	62-0205	7
24-1516	50	26-0051	51	31-0013	43	33-000F	40	33-3164R	41	36-0001P	46	38-0007	42	40-2164	41	45-5000	36	62-0206	21
24-20002	50	27-0013	51	31-0014	43	33-000U	40	34-0014	44	36-0012	46	38-0008	42	40-2364	41	45-500V	35	62-0207	9
25-0012	50	27-0014	51	31-0015	43	33-0012	40	34-0038	44	36-0716	46	38-0009	42	40-2564	41	45-6000	36	62-0208	21
25-0034	50	27-0016	15	31-0016	43	33-0014	40	34-0116	44	36-1332	46	38-0010	42	40-2764	41	52-0001	6	62-0209	10
25-0058	50	27-0017	51	31-0017	43	33-0018	40	34-0316	44	36-1532	46	38-0011	42	40-2964	41	52-0002	7	62-0240	21
25-0078	50	27-0019	51	31-0018	43	33-0038	40	34-0332	44	36-2564	46	38-0012	42	40-3164	41	52-0003	8	62-0245	6
25-0916	50	27-0021	51	31-0019	43	33-0116	40	34-0516	44	36-2764	46	38-0013	42	44-0012	47	52-0004	9	62-0308	21
25-10001	50	27-0022	51	31-0020	43	33-0316	40	34-0532	44	36-2964	46	38-0015	42	44-0014	47	52-0312	5	62-0311	21
25-10012	50	27-0024	51	31-0021	43	33-0332	40	34-0564	44	36-3164	46	38-0025	42	44-0018	47	52-1100	6	62-0312	5
25-10014	50	27-0025	51	31-0022	43	33-0364	40	34-0732	44	37-0001	44	38-0033	42	44-0038	47	52-1200	7	62-0315	5
25-10018	50	27-0027	51	31-0023	43	33-0516	40	34-0764	44	37-0002	44	38-0035	42	44-0116	47	52-1300	9	62-0318	5
25-10034	50	27-0029	51	31-0024	43	33-0532	40	34-0932	44	37-0003	44	38-0042	42	44-0316	47	52-1600	6	62-0360	21
25-10038	50	27-0030	51	31-0025	43	33-0564	40	34-0964	44	37-0004	44	38-0045	42	44-0332	47	52-1700	7	62-0412	5
25-10058	50	27-0032	51	31-0026	43	33-0716	40	34-1132	44	37-0005	44	38-0055	42	44-0364	47	52-1900	9	62-0415	5
25-10078	50	27-0033	51	31-0027	43	33-0732	40	34-1164	44	37-0006	44	38-0065	42	44-0516	47	52-2701	6	62-0516	7
25-10116	50	27-0035	51	31-0028	43	33-0764	40	34-1364	44	37-0007	44	38-0067	42	44-0532	47	52-2702	7	62-0524	18
25-10316	50	27-0037	51	31-0029	43	33-0932	40	34-1564	44	37-0008	44	38-0075	42	44-0564	47	52-2703	8	62-0532	7
25-10615	50	27-0038	51	31-0030	43	33-0964	40	34-1764	44	37-0009	44	38-0085	42	44-0716	47	52-2704	9	62-0536	18
25-10716	50	27-0040	51	31-0031	43	33-1132	40	34-1964	44	37-0010	44	38-0095	42	44-0732	47	61-2012	20	62-0540	18
25-10916	50	27-0041	51	31-0032	43	33-1164	40	34-2164	44	37-0011	44	38-0102	42	44-0764	47	61-2018	20	62-0550	18
25-11116	50	27-0043	51	31-0033	43	33-1332	40	34-2364	44	37-0012	44	38-0105	42	44-0932	47	61-2060	20	62-0560	18
25-1116	50	27-0044	51	31-0034	43	33-1364	40	35-0001	46	37-0013	44	38-0115	42	44-0964	47	61-2080	20	62-0580	18
25-11316	50	27-0046	51	31-0035	43	33-1532	40	35-0002	46	37-0014	44	38-0125	42	44-1132	47	61-3012	20	62-0716	9
25-11516	50	27-0048	51	31-0036	43	33-1564	40	35-0112	46	37-0015	44	38-1000	42	44-1164	47	61-3018	20	62-0724	18

Item #	Page	Item #	Page	Item #	Page	Item #	Page	Item #	Page	Item #	Page	Item #	Page	Item #	Page	Item #	Page
62-0732	9	62-3040	21	63-0540	19	72-4005	32	81-1700	7	82-2800	16	84-360R	23	88-7001	53	99-834F	12
62-0736	18	62-3060	21	63-0550	19	72-4006	32	81-1900	9	82-2802	16	84-380R	23	88-7002	53	99-834M	12
62-0750	18	62-3080	21	63-0560	19	72-4006A	32	82-0030	25	82-2803	16	84-3CRR	24	88-7003	53	99-878C	12
62-0758	18	62-3120	21	63-0580	19	72-4007	32	82-0033	6	82-2805	17	84-3FIR	24	88-7004	53	99-878F	12
62-0760	18	62-3180	21	63-0607	19	72-4007A	32	82-0044	7	82-2806	17	84-3MER	24	88-8001	53	99-878M	12
62-0858	10	62-3205	7	63-0736	19	72-4008	32	82-0050	9	82-2807	17	84-3VFR	24	88-9001	53	M-1295	55
62-1100	6	62-3206	8	63-0750	19	72-4009	32	82-0060	10	82-2810	16	84-3XCR	24	88-9002	53	M-1323	55
62-1122	21	62-3207	9	63-0780	19	72-4106	32	82-0205	7	82-2811	16	84-9GRE	22	88-9003	53	M-1324	55
62-1126	21	62-3209	10	63-4536	19	72-4110	32	82-0207	9	82-2812	16	84-9MAR	22	92-1001	22	M1-1326	55
62-1128	21	62-3240	21	63-4540	19	72-4120	32	82-0209	10	82-2813	16	84-9TAN	22	92-1002	22	M-1500	55
62-1160	7	62-3245	6	62-4550	19	72-4440	30	82-0245	6	82-2814	17	84-RGRE	22	92-1005	22	M-1600	55
62-1200	7	62-3260	21	62-4560	19	72-4445	30	82-1100	6	82-2815	17	84-RMAR	22	92-1201	22	M-1700	55
62-1250	8	62-3280	21	63-4580	19	72-4450	30	82-1200	7	82-2816	17	84-RTAN	22	92-1202	22	M-1800	55
62-1300	9	62-3565	5	66-0005	19	72-4460	30	82-1250	8	82-3800	16	85-045G	20	92-1205	22	M-1900	55
62-1300A	28	62-4001	32	66-0007	19	72-4500	29	82-12A1	10	82-3801	16	85-45M	20	92-1801	22	M-24DPI	56
62-1301	28	62-4004	32	66-0045	19	72-4510	29	82-12A2	10	82-3802	161	85-050G	20	92-1802	22	M-24DPY	56
62-1302	21	62-4006A	32	66-0125	19	72-4501	29	82-12F1	10	82-3803	16	85-050M	20	92-1805	22	M-3000	55
62-1304	21	62-4007A	32	66-0150	19	72-4938	31	82-1225	10	82-3810	16	85-220R	23	92-2401	22	M-3011	55
62-1306	21	62-4012	5	66-1420	19	72-5000	30	82-1300	9	82-3811	16	85-224R	23	92-2402	22	M-3012	55
62-1308	21	62-4014	5	66-5811	19	72-5500	29	82-1425	10	82-3812	16	85-236R	23	92-2405	22	M-4000	55
62-1312	5	62-4018	5	68-001A	25	72-5501	29	82-14A1	10	82-3813	16	85-250R	23	92-3201	22	M-400B	55
62-1315	5	62-4106	32	68-002A	25	72-5510	29	82-14A2	10	82-3820	16	85-260R	23	92-3202	22	M-4001	55
62-1324	21	62-4110	32	68-004R	25	72-6000	30	76-9720	36	82-6800	17	85-280R	23	92-3205	22	M-4001B	55
62-1400	28	62-4116	5	68-006R	25	72-600T	31	81-1600	6	82-6801	17	85-2CRR	23	92-6001	22	M-4002	55
62-1405	10	62-4120	32	68-007R	25	72-6440	30	81-1700	7	82-6802	17	85-2MER	23	92-6002	22	M-4002B	55
62-1500	28	62-4132	5	68-0045R	25	72-6445	30	81-1900	9	82-6803	17	85-320R	23	92-6005	22	M-4003	55
62-1600	6	62-4440	30	68-050R	25	72-6450	30	82-0030	25	82-6810	17	85-324R	23	92-8001	22	M-4003B	55
62-1666	8	62-4445	30	68-070R	25	72-6460	30	82-0033	6	82-6811	17	85-336R	23	92-8002	22	M-4046	55
62-1700	7	62-4450	30	68-400R	25	72-7000	30	82-0044	7	82-6812	17	85-350R	23	92-8005	22	M-4047	55
62-1800	8	62-4460	30	72-001B	31	72-7501	33	82-0050	9	82-6813	17	85-360R	23	99-0010	12	M-5000	56
62-1900	9	62-4501	29	72-0002	31	72-7503	33	82-0060	10	82-6820	17	85-380R	23	99-0634	12	M-5001	56
62-2012	5	62-4510	18	72-0002B	31	72-7601	33	82-0205	7	82-6821	17	85-3CRR	24	99-0701	12	M-5003	56
62-2014	5	62-4516	6	72-0003	31	72-7603	33	82-0207	9	82-6822	17	85-3MER	24	99-0714	12	M-5005	56
62-2018	5	62-4524	18	72-0009	31	72-7701	33	82-0209	10	82-6823	17	88-0001	53	99-0801	12	M-9000B	55
62-2106	21	62-4532	6	72-0010	31	72-7702	33	82-0245	6	82-8812	11	88-0002	53	99-0814	12	M-9001B	55
62-2108	21	62-4536	18	72-000A	5	72-7703	33	82-1100	6	82-8814	11	88-1001	52	99-0878	12		
62-2116	5	62-4540	18	72-000B	5	72-7704	33	82-1200	7	82-8816	11	88-1002	52	99-101C	12		
62-2118	21	62-4550	18	72-0030	29	72-7705	33	82-1250	8	82-8820	11	88-1003	52	99-101F	12		
62-2120	21	62-4560	18	72-0031	29	72-7706	33	82-12A1	10	84-0024	24	88-1004	52	99-101M	12		
62-2122	21	62-4580	18	72-0040	29	72-7707	33	82-12A2	10	84-002R	24	88-1006	52	99-114C	12		
62-2126	21	62-4616	6	72-0050	29	72-7712	33	82-12F1	10	84-0036	24	88-1008	52	99-114F	12		
62-2127	21	62-5100	18	72-1000	30	72-7758	33	82-1225	10	84-003R	24	88-1010	52	99-114M	12		
62-2128	21	62-5120	18	72-1000T	31	72-7734	33	82-1300	9	84-0060	24	88-1012	52	99-601C	12		
62-2162	21	62-5500	29	72-1300	28	72-7801	33	82-1425	10	84-00TK	24	88-1605	53	99-601F	12		
62-2164	21	62-5501	29	72-1301	28	72-7901	33	82-14A1	10	84-220R	23	88-1607	53	99-601M	12		
62-2165	21	62-5516	7	72-1310	31	72-7902	33	82-14A2	10	84-224R	23	88-1609	53	99-634C	12		
62-2166	21	62-6440	30	72-1400	28	72-8000	30	82-14F1	10	84-236R	23	88-2001	52	99-634F	12		
62-2168	21	62-6445	30	72-1401	28	72-800T	31	82-1500	5	84-260R	23	88-2002	52	99-634M	12		
62-2710	6	62-6450	30	72-1500	28	76-2001	36	82-1600	6	84-280R	23	88-2003	52	99-701C	12		
62-2711	6	62-6460	30	72-1501	28	76-2004	36	82-1601	6	84-2CRR	24	88-3001	52	99-701F	12		
62-2720	7	62-6616	8	72-3000	28	76-2025	36	82-16A2	10	84-2FIR	24	88-3002	52	99-701M	12		
62-2721	7	62-7016	9	72-3001	28	76-2101	36	82-16F1	10	84-2MER	24	88-3003	52	99-801C	12		
62-2745	6	62-7100	18	72-3002	28	76-2104	36	82-1700	7	84-2VFR	24	88-3004	52	99-801F	12		
62-2761	8	62-8812	11	72-3003	28	76-2125	36	82-1701	7	84-2XCR	24	88-4001	52	99-801M	12		
62-2770	9	62-8814	11	72-4001	32	76-9701	36	82-1800	8	84-320R	23	88-5001	52	99-814C	12		
62-2771	9	62-8816	11	72-4002	32	76-9704	36	82-1801	8	84-324R	23	88-5002	52	99-814F	12		
62-3001	28	62-8820	11	72-4003	32	76-9720	36	82-1900	9	84-336R	23	88-6001	52	99-814M	12		
62-3002	28	63-0536	19	72-4004	32	81-1600	6	82-1901	9	84-350R	23	88-6002	52	99-834C	12		

ALSO AVAILABLE:



AVAILABLE HERE:

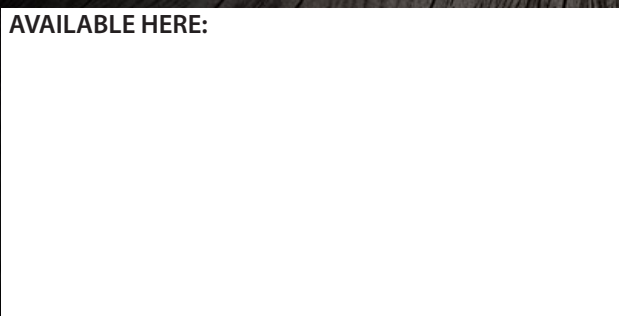

AMETA
SOLUTION.COM